

GB



Operating Instructions

Stud welding devices

BMS-9

BMS-9V

Stud welding guns

PS-9

PS-9K

PS-1K





Device numbers

We recommend to enter the device numbers in the list so that they can be accessed quickly if servicing is required.

Device		Type	Serial number
Stud welding device		BMS-9	
		BMS-9V	
Stud welding gun		PS-9	
Stud welding gun		PS-9K	
Stud welding gun		PS-1K	

Operating Instructions

Document no.: P00161, 02-2017, translation of the original instructions
(English: P00261)

All information in this document is the property of Heinz Soyer
Bolzenschweißtechnik GmbH.

Revision status

Document	created / amended	Editor	Date
Original	created	MS/IS	25.04.2019
	Amended	MS	01 February 2021

Contents

1	General information	5
1.1	<i>Validity of the operating instructions</i>	5
1.2	<i>Declarations of conformity.....</i>	5
1.3	<i>Manufacturer</i>	7
1.4	<i>Instruction, training.....</i>	7
1.5	<i>Standards and directives.....</i>	7
2	Important safety instructions.....	8
2.1	<i>Warning signs used.....</i>	8
2.2	<i>General safety instructions.....</i>	9
2.3	<i>Personal protection equipment</i>	12
2.4	<i>Intended use of the stud welding device.....</i>	13
2.4.1	<i>Incorrect use</i>	13
2.5	<i>Intended use of the stud welding guns</i>	13
2.5.1	<i>Incorrect use</i>	13
2.6	<i>Operating company prerequisites</i>	14
2.6.1	<i>Prerequisites for personnel.....</i>	14
3	Transport.....	15
4	Storage, shutdown.....	15
5	Disposal	15
6	Description of BMS-9(V) stud welding devices.....	16
6.1	<i>Type differentiation.....</i>	16
6.2	<i>Working method</i>	16
6.2.1	<i>Product features.....</i>	16
6.2.2	<i>Capacitor discharge stud welding.....</i>	17
6.3	<i>Overview of the controls.....</i>	18
6.3.1	<i>Displaying the operating states.....</i>	19
6.4	<i>Technical data for BMS-9(V) stud welding device</i>	20
6.5	<i>Permitted stud welding guns</i>	21
6.6	<i>Cleaning of the stud welding device</i>	22
7	Description of the PS-9 and PS-9K stud welding guns.....	23
7.1	<i>Type differentiation.....</i>	24
7.2	<i>Meaning of the LED ring displays</i>	24
7.3	<i>Technical data for PS-9(K) stud welding guns.....</i>	25
7.4	<i>Cleaning of the stud welding gun.....</i>	26
8	Description of the PS-1K stud welding gun	27
8.1	<i>Technical data for PS-1K stud welding gun</i>	28
8.2	<i>Cleaning of the stud welding gun</i>	29
9	Description of the stud chuck.....	30
9.1	<i>Non-adjustable stud chucks</i>	30
9.2	<i>Adjusting and installing adjustable stud chucks.....</i>	32
10	Setup and connection.....	35
10.1	<i>Requirements for the installation location</i>	35



10.2	Connection of the stud welding device and the stud welding guns	36
10.2.1	Mains connection.....	36
10.2.2	Connecting the earth cable	36
10.2.3	Connecting the stud welding gun	38
11	Settings	39
11.1	Adjusting the charging voltage and lift time on the stud welding device.....	39
11.1.1	Device adjustment tables	39
11.1.2	Adjusting the charging voltage	41
11.1.3	Adjusting the lift time (height of lift) in the "Setup" mode	42
12	Welding operation	45
12.1	Carrying out welding	45
12.2	Notes on checking the quality of the weld.....	46
12.2.1	Visual inspection.....	46
12.3	Switching off the device	48
12.4	Welding defects and their causes	49
12.5	Malfunctions with an error message	50
13	Maintenance and repair	52
14	Service.....	52
15	Warranty conditions	52



1 General information

These operating instructions contain important information and requirements for the operation of the devices. Keep the operating instructions in a readily accessible location close to the devices.

In these operating instructions, the term "devices" refers to the stud welding device and the stud welding gun.

Carefully read the operating instructions and any other documents contained in the technical documentation. Pay particular attention to the safety instructions which are intended to help you recognise any possible residual risks and prevent hazards.

The drawings and illustrations in these operating instructions are for illustrative purposes and may vary slightly from the actual equipment.

The manufacturer reserves the right to make technical changes.

1.1 Validity of the operating instructions

These operating instructions apply to the following devices:

Stud welding devices	BMS-9 BMS-9V
Stud welding guns	PS-9 PS-9K PS-1K

1.2 Declarations of conformity

The devices are designed and constructed in accordance with the general accepted codes of practice.



Please note that significant changes to the device will cause the declaration of conformity to become void.

Furthermore, the manufacturer's warranty may be rendered invalid.



Stud welding device

**Heinz Soyer Bolzenschweißtechnik GmbH
Inninger Straße 14
82237 Wörthsee**

CE Declaration of Conformity

We herewith declare that the machine described in the following and the version available on the market correspond in design and construction to the safety and health requirements of the listed guidelines and standards. Any unauthorised modification to this machine automatically annuls this declaration.

Designation of machine	:	<u>Stud welding device</u>
Machine type	:	<u>BMS-9</u> <u>BMS-9V</u>
Machine no.	:	_____
Applicable EU directives	:	RoHS Directive (2011/65/EU) Low Voltage Directive (2014/35/EU) EMC Directive (2014/30/EU)
Applied harmonised standards, in particular	:	EN 60 974-1:2018 + A1:2019 EN 60 974-10:2016
Applied national standards	:	DGUV Regulation 1
Date	:	01 February 2021
Producer's signature	:	 _____
Signer's function	:	Managing Director

1.3 Manufacturer

The manufacturer of the devices is:
Heinz Soyer Bolzenschweißtechnik GmbH
Inninger Straße 14
82237 Wörthsee
Phone: 0049-8153-885-0
Fax: 0049-8153-8030
Email: info@soyer.de
Web: www.soyer.de, www.soyer.com

1.4 Instruction, training

Soyer offers optional and individual instruction in the operation of the devices.
Soyer also offers training for customer-specific use of the devices.
The tutorial is available at

<https://youtu.be/QRyjCVNdRZk>.

Information on the scope and costs of instruction and training can be obtained from Soyer GmbH.



**Also see our video instructions at
www.youtube.com/user/SoyerGmbH.**

1.5 Standards and directives

The following standards, inter alia, must be observed for carrying out stud welding work and for the qualification of personnel:

- DIN EN ISO 14555 Welding - Arc stud welding of metallic materials
- DIN EN ISO 14732 Welding personnel - Qualification testing of welding operators and weld setters for mechanized and automatic welding of metallic materials
- DIN EN 60974-9 Arc welding equipment - Installation and use
- DVS Bulletin 0903 Capacitor discharge stud welding with tip ignition(CD)
- DVS Bulletin 0904 Instruction for practice - Arc stud welding









2 Important safety instructions

Read the following chapter carefully and follow the safety instructions. Please contact the manufacturer if you are uncertain or an instruction cannot be followed.

The devices have been constructed in accordance with the generally accepted codes of practice and established and usual safety requirements were observed and applied. In order to reach maximum safety, it is absolutely necessary to follow and observe all safety instructions specified in these operating instructions.

2.1 Warning signs used

Warning signs are used in this document, depending on the potential danger of the situation.



Safety and information symbols used in this manual	
	This warning sign indicates imminent danger leading to severe injuries or death.
	This warning sign indicates a potentially dangerous situation that may lead to severe injuries or death.
	This warning sign indicates a potentially dangerous situation that may lead to minor injuries. Without the warning triangle, this warning sign is also used in the event of danger of material damage.
	Additional sign indicating danger from electric current. The additional sign is used in connection with a warning.
	Additional sign indicating the danger of burns. The additional sign is used in connection with a warning.
	Do not touch the surface or the housing: Shock hazard.
	Do not touch or open, danger to unauthorised persons.
	Danger to persons with medical implants such as pacemakers.
	The information sign is not a warning sign. It indicates important and useful information on the subject.

Safety instructions on the device

As an additional warning of danger, warning labels can be found on the devices. Warning labels are affixed by the manufacturer and must not be removed. If a warning label is damaged and thus illegible, a new warning label must be affixed immediately.

Warning labels must be obtained from the manufacturer.

2.2 General safety instructions



Danger from electric current, general information

When working on live components, there is a danger to life from electric current.

- Work on electric or electronic components may only be performed by trained electrotechnical personnel in accordance with currently applicable electrotechnical regulations.
- Protection devices must not be manipulated or disabled. Protection devices include, for example, housing and housing cover, fuses or power switches.
- If protection devices have to be removed for maintenance work, the device may only be switched on again when all protection devices are installed and their functionality has been checked.
- Starting the device with faulty protection devices is not permitted. Faulty protective devices must be repaired or replaced immediately. Unintentional operation by third parties must be prevented.

 **DANGER**



Danger from electric current during maintenance and repair work

When working on live components, there is a danger to life from electric current.

- Work on electric or electronic components may only be performed by trained electrotechnical personnel of Soyer Bolzenschweißtechnik.
- Before performing any work on the stud welding device, the mains switch of the device must be turned off and the mains plug must be disconnected.
- Before performing any work on the stud welding gun, the supply cables to the stud welding device must be disconnected.
- If protection devices have to be removed for maintenance work, the device may only be switched on again when all protection devices are installed and their functionality has been checked.

 **DANGER**



Danger from magnetic fields

In the area surrounding the device, strong magnetic fields which may influence medical auxiliary devices and therefore result in danger to life occur during the welding process.

- Persons with electric medical aids (e.g. pacemakers) must stay away from the devices.
- The operating personnel must ensure that persons with medical aids stay away from the devices.

 **DANGER**

Danger of explosion from inappropriate operation sites in explosive areas

The device is not designed for use in explosive areas.

- The device must not be installed and operated in explosive areas.

CAUTION**Danger of burns from hot surfaces**

During the welding process, the workpieces and some parts of the welding gun get so hot that touching them may cause burns.

- Always use personal protective equipment.
- Before working on hot parts of the device, check if they have cooled down.

WARNING**Danger of burns from hot welding spatters**

During the welding process, dangerous welding spatters may occur.

- Always use personal protective equipment.

WARNING**Danger of fire from hot welding spatters**

Welding spatters or hot workpieces occurring during the welding process may cause danger of fire.

- Do not store combustible or highly flammable materials in the welding area.

2.3 Personal protection equipment





It is recommended to wear personal protective equipment when working with the stud welding device.

WARNING

Danger from missing or incorrect personal protective equipment

Stud welding may lead to danger of burns, especially due to hot welding spatters. Danger of blinding may also arise due to the occurrence of strong arcs.

- Always wear suitable, closed protective clothing.
- Type and extent of the required protective equipment depend on the respective occurrence of welding spatters and/or arcs. Both occurrences vary, depending on the basic material, stud material, stud size and the required welding performance.
- Please observe the following instructions for protective equipment.

Recommended personal protective equipment	
	<p>Safety goggles</p> <p>Welding spatters and a flash occur during the welding process. In order to protect your eyes, wear appropriate safety goggles with side protection and a filter protector, if necessary.</p>
	<p>Protective gloves</p> <p>During the welding process, the workpieces and components of the welding gun get hot and welding spatters occur. Wear appropriate, incombustible, heat-resistant protective gloves.</p>
	<p>Protective clothing</p> <p>Welding spatters occur during the welding process. Wear appropriate, incombustible and, if necessary, heat-resistant protective clothing.</p>
	<p>Safety footwear</p> <p>Welding spatters occur during the welding process. Wear appropriate, incombustible, heat-resistant safety footwear.</p>
	<p>Hearing protection</p> <p>Relatively loud welding noises may occur, depending on the welding device and the welding application. In that case, wear appropriate hearing protection.</p>

2.4 Intended use of the stud welding device

With the SOYER® BMS-9 capacitor discharge stud welding device, pins and threaded studs from M3 to M8 (M3 to M10 with BMS-9V) as well as many different weld fasteners made of steel, stainless steel, aluminium and brass can be welded in accordance with DIN EN ISO 13918 (capacitor discharge).

Special studs or diameters upon request.

The stud welding device can only be operated with the welding guns described in chapter "6.5 Permitted stud welding guns" on page 21.

The stud welding device must be operated within the scope of technical data.

2.4.1 Incorrect use

Any use of the device deviating from the intended use is considered as not intended.

Not intended use, unauthorised modification or manipulation of the device will void the declaration of conformity and warranty claims against the manufacturer.

2.5 Intended use of the stud welding guns

With the SOYER® stud welding guns, pins and threaded studs from M3 to M8 (up to M10 with special gun and adapter) as well as many different weld fasteners made of steel, stainless steel, aluminium and brass can be welded in accordance with DIN EN ISO 13918 (capacitor discharge).

Special studs or diameters upon request.

The stud welding guns can only be operated with the stud welding devices described in chapter "7.3 Technical data for PS-9(K) stud welding guns" on page 25 and chapter "8.1 Technical data for PS-1K stud welding gun" on page 28.

The stud welding gun can only be operated within the scope of technical data.

2.5.1 Incorrect use

Every use of the welding gun deviating from the intended use is considered as not intended.

Not intended use, unauthorised modification or manipulation of the device will void the declaration of conformity and warranty claims against the manufacturer.

Misusing the gun as a tool, e.g. as a striking tool for checking the welding quality, is not permitted.

2.6 Operating company prerequisites

The operating company of the device must ensure that the prerequisites described in these operating instructions for a safe operation of the device are met.

These include, for example, conditions at the installation location, regulatory requirements on a safe workplace, instruction of operating personnel and qualified personnel in using the device, if applicable, compliance with required maintenance work as well as monitoring the intended use of the device.

These operating instructions must be stored in the vicinity of the device.

The operating company of the device must ensure that all protective devices are present, active and intact before the device is used.

2.6.1 Prerequisites for personnel

Operating personnel

Persons authorised to operate the device must be familiar with the device and trained accordingly. They must have read and understood these operating instructions. When working on the device, they must also be able to avert possible residual danger to themselves or third parties or minimise them as far as possible.

To retain this qualification, safety training must be carried out at least once a year. If necessary, specially trained personnel or the manufacturer must be consulted in case of failure or for maintenance work.

Operators of stud welding devices must have technical expertise for operating and adjusting the device properly as well as for properly carrying out weldings.

If welding personnel has to be qualified for certification of welding, the standards DIN EN ISO 14555 and DIN EN ISO 14732 are to be observed.

Trained electrotechnical personnel

As a general principle, works on live elements may only be performed by qualified electricians. This work must be performed in accordance with the applicable technical rules for electrotechnical devices.



All devices of Soyer Bolzenschweißtechnik GmbH must only be opened by personnel of Soyer or by personnel authorised by Soyer.

3 Transport

When transporting the device, make sure that it cannot be damaged. Appropriate packaging can protect the device against weathering effects, especially moisture.

4 Storage, shutdown

During storage or shutdown, make sure to protect the device against dirt and humidity.

Protect the device against unauthorised access by third parties.

5 Disposal

Local environmental directives must be observed when disposing of the device.

Water-endangering as well as environmentally hazardous substances are to be disposed of in accordance with legal regulations.

If applicable, materials must be separated according to regulations.

6 Description of BMS-9(V) stud welding devices

The main elements of the stud welding device and its features are described in the following.

6.1 Type differentiation

The difference between the device types BMS-9 and BMS-9V described in this instruction lies in the different performances of the capacitor banks and therefore in the welding performance.

Designation Order number	Feature
BMS-9 P01070	Capacitor bank: 66,000 μ F Maximum welding stud diameter: M8
BMS-9V P01071	Capacitor bank: 99,000 μ F Maximum welding stud diameter: M8 (M10 with special welding gun)

6.2 Working method

With the SOYER® BMS-9 stud welding device, pins and threaded studs from M3 to M8 (M10 with BMS-9V and special gun) as well as many different weld fasteners made of steel or stainless steel can be welded in accordance with DIN EN ISO 13918 (capacitor discharge).

Welding of weld fasteners made of aluminium and brass is also possible.

The LED display makes the operator's job easier and also considerably contributes to increasing the quality of the welded joints.

6.2.1 Product features

- Simple selection of welding parameters using control keys
- Automatic recognition of the mains voltage 115/230V~
- Inverter switch-mode power supply for maximum welding capacity
- Automatic recognition of the welding gun (gap/contact)
- Control of the optical LED illuminated ring on the PS-9(K) welding gun
- High capacity with compact structure and low weight
- Automatic storage of charging voltage
- Short charging cycles to increase productivity
- Precise digital display of the charging voltage
- Monitoring of all functions using a clear functional display panel

6.2.2 Capacitor discharge stud welding

The SOYER® BMS-9 stud welding device operates according to the principle of capacitor discharge with tip ignition.

This system uses the sudden discharge of a capacitor bank to generate arc energy.

Functional principle

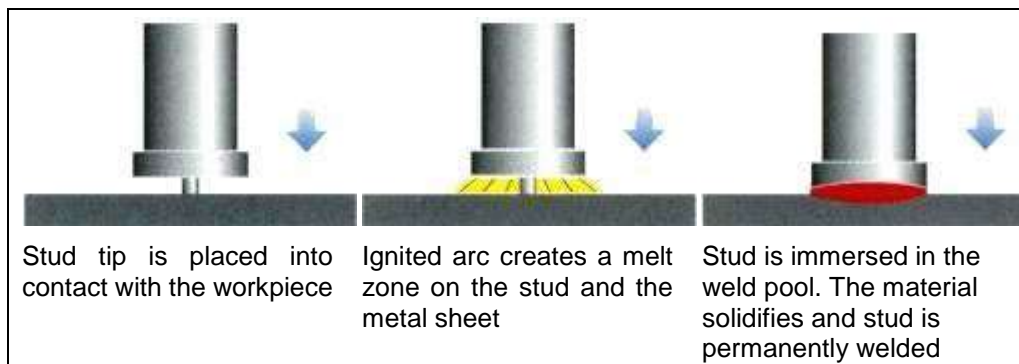

For more information on this subject, please visit: www.soyer.com.

6.3 Overview of the controls

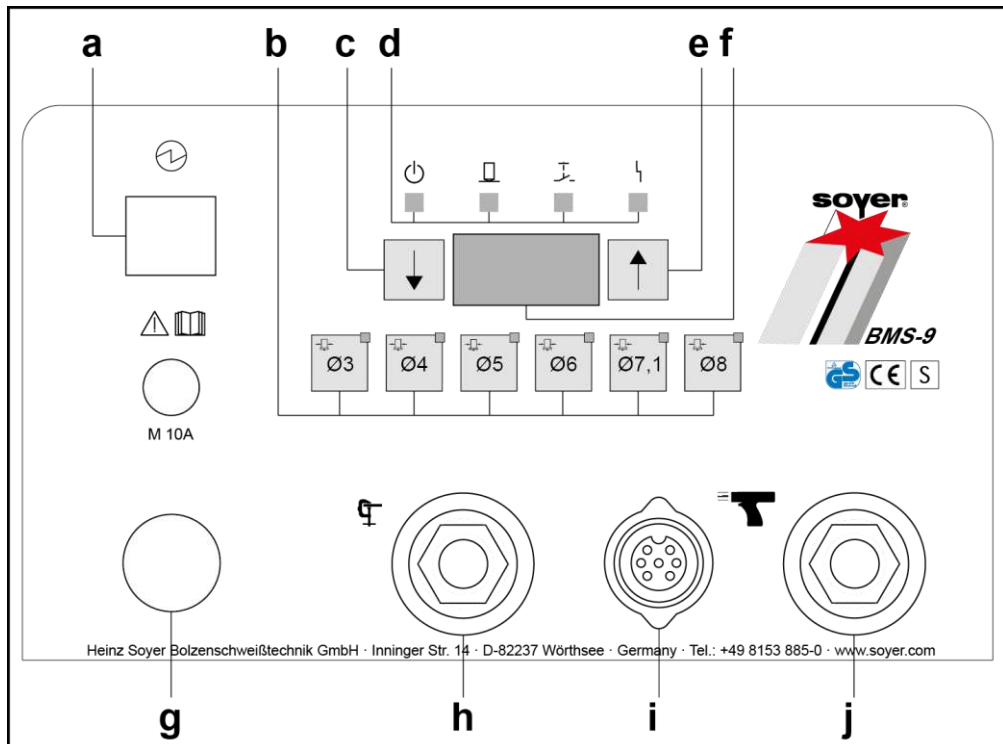

Figure 1: Overview of the front panel

Item	Designation
a	Mains switch for switching the device ON/OFF
b	Selection keys for quick, direct preselection of the stud diameter and charging voltage (see chapter "11.1.1 Device adjustment tables" on page 39).
c	Function key to decrease the displayed charging voltage
d	Display of operating states, for explanation see chapter "6.3.1 Displaying the operating states" on page 19.
e	Function key to increase the displayed charging voltage
f	Display
g	Mains cable
h	Socket for the connection of the earth cable
j	7-pin connection socket for the control cable
k	Socket for the connection of the welding cable

6.3.1 Displaying the operating states

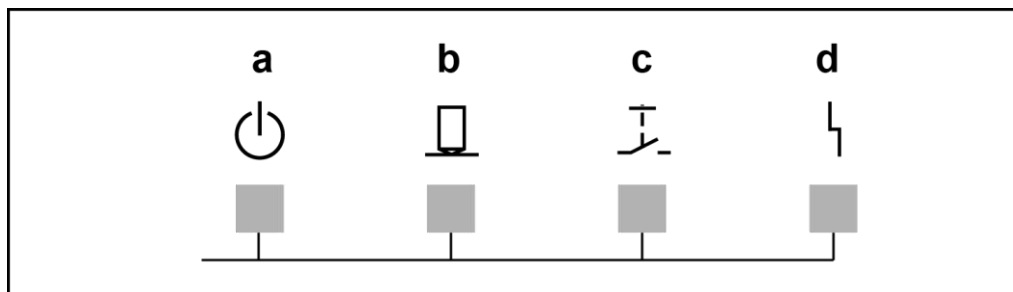

Figure 2: Operating states

Item	Designation
a	<p>Ready</p> <p>In normal operation, the LED lights up when the stud welding device is ready for operation in normal mode.</p>
b	<p>Stud on workpiece</p> <p>LED lights up when the earth terminal is connected and the stud touches the workpiece.</p>
c	<p>Release</p> <p>LED lights up when the release button on the welding gun is pressed.</p>
d	<p>Malfunction</p> <p>The LED lights up when a malfunction of the stud welding device occurs. See chapter "12.5 Malfunctions with an error message" on page 50.</p>



6.4 Technical data for BMS-9(V) stud welding device

Designation	BMS-9 / BMS-9 V stud welding device
Welding process	Capacitor discharge stud welding
Standard gun	PS-9
Welding area	M3 - M8 or Ø 3 - 8 mm for steel, stainless steel, aluminium and brass (M8 or Ø 8 in aluminium and brass conditionally, depending on the respective requirements)
Current source	Capacitor bank 66,000 µF (Option for BMS-9V 99,000 µF)
Charging voltage	50 - 200 V infinitely variable up/down
Welding sequence	Up to 20 stud/min (depending on stud diameter and type of feed)
Mains connection	Automatic recognition 115/230 V, 50/60 Hz, 10 A
Fuse	M 10 A (fuse 5x20mm semi time-lag)
Type of cooling	F
Protection class	IP 21
Dimensions	295 x 170 x 295 mm (w x h x d)
Weight	BMS-9 (7.9 kg) / BMS-9V (9.1 kg)
Colour	RAL 5009 azure blue
Subject to technical changes	

6.5 Permitted stud welding guns

WARNING

Hazards due to wrong gun

Hazards for the operator may occur when a wrong welding gun is used.

- Only use welding guns hereinafter permitted by Soyer.

The use of other guns or guns from another manufacturer will invalidate the declarations of conformity and the warranties of Soyer.

Overview of permitted stud welding guns

Gun	Stud welding device	
	BMS-9	BMS-9V
PS-0K	M3- M8 ⁽¹⁾	M3- M8 ⁽¹⁾
PS-1K	M3- M8 ⁽¹⁾	M3- M8 ⁽¹⁾
PS-3K Stativ	M3- M8 ⁽¹⁾	M3- M10 ⁽¹⁾
PS-9	M3- M8	M3- M8
PS-9K	M3- M8	M3- M8
PS-2KS	M3- M8	M3- M8
PS-3	M3- M8 ⁽¹⁾	M3- M8 ⁽¹⁾
SK-1 T-Nut	M3- M8 ⁽¹⁾	M3- M8 ⁽¹⁾
SK-5 T-Nut	M3- M8 ⁽¹⁾	M3- M8 ⁽¹⁾

(1): Possible with optional adapter plug and adapter cable.

Adapter plug for the welding cable:	25/50 #E04027
Adapter cable for the control cable:	7pin/15pin #F06009

6.6 Cleaning of the stud welding device

DANGER

Dangers during cleaning

Improper cleaning of the stud welding device can endanger personnel.

- The device may only be cleaned by trained specialists.
- Before any cleaning work is done, the stud welding device must be disconnected from the main power supply and secured against accidental switch-on.
- Work on electrical devices and components may only be performed by skilled electricians in accordance with electrotechnical regulations.
- Make sure that no liquids get into the device.

Do not use aggressive cleaning agents for cleaning the device.

Please make sure that any cleaning waste is disposed of in an environmentally safe manner. Please observe the instructions of the detergent manufacturer.

CAUTION

Damage to the device due to incorrect cleaning

Improper cleaning may cause damage to the device.

- Make sure that no liquids get into the device.
- Do not use aggressive detergents for cleaning the device.

The frequency of cleaning depends on the operating conditions of the stud welding device.

7 Description of the PS-9 and PS-9K stud welding guns

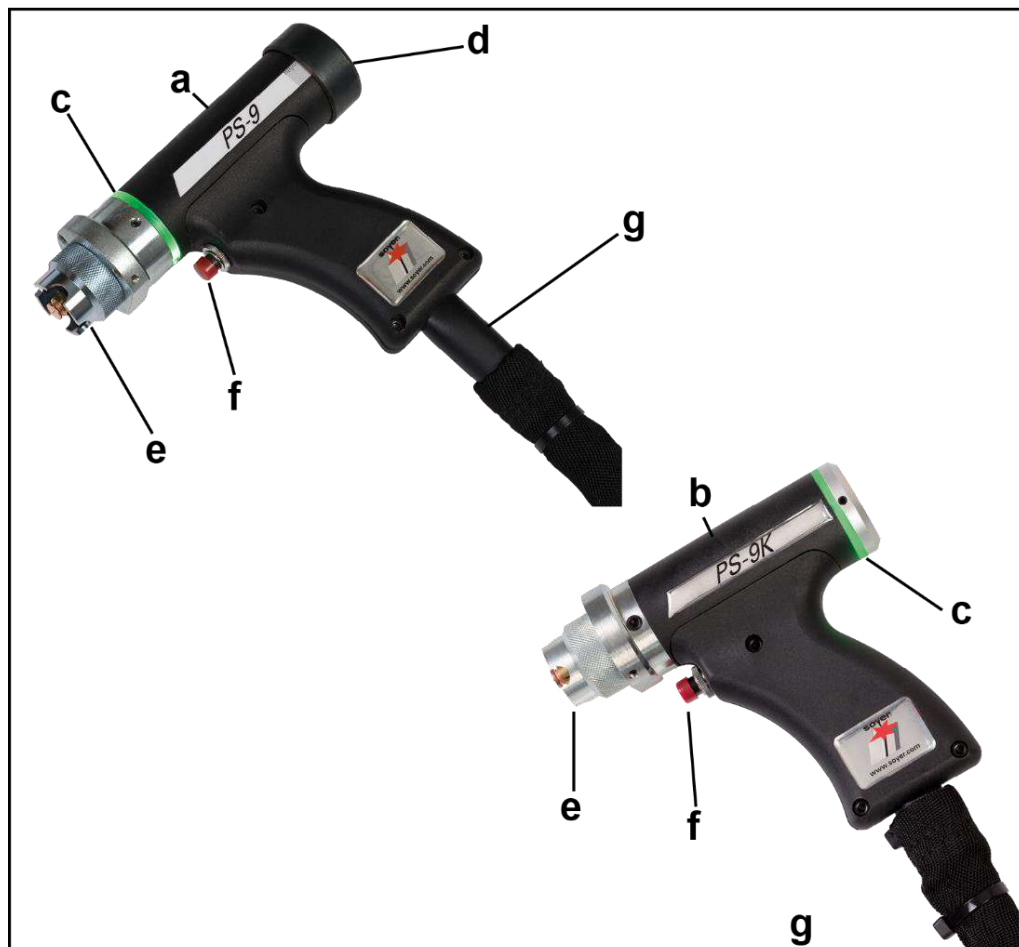

Figure 3: PS-9 and PS-9K stud welding guns

Item	Designation
a	PS-9 stud welding gun, gap welding gun with lifting magnet
b	PS-9K stud welding gun, contact welding gun without lifting magnet
c	LED ring for status display of the gun
d	Adjustment wheel for setting the height of lift/lift time (only PS-9)
e	Support tube
f	Release button
g	Power and control cable for connection to the stud welding device



The PS-9 and PS-9K stud welding guns may only be operated with the stud welding devices specified in the technical data.



7.1 Type differentiation

The two guns differ in the method by which the stud is positioned on the workpiece during welding.

PS-9:

The gun has a lifting magnet. Before welding, the stud is lifted by a magnet and automatically lowered again for welding (gap welding gun).

The height of the lift is also crucial for the weld result. The lift height can be determined using the lift time with the aid of the BMS-9(V) stud welding device. To do so, observe chapter "11.1.3 Setting the lift time (height of lift) in the "Setup" mode" on page 42.

The height of lift is set using the adjusting wheel on the gun.

PS-9K:

Due to a projection on the support tube and a spring in the gun, the stud of this gun is pressed firmly to the workpiece (contact gun).

The stud is not lifted before welding.

7.2 Meaning of the LED ring displays

The two guns have a LED illuminated ring that informs you of the status of the gun.

LED display	Meaning
Green flashing	Gun is in standby mode and is ready.
Green continuous light	Gun is positioned on workpiece and ready for welding. Required earth contact established. Welding is carried out by pressing the release button.
Red continuous light	A fault has occurred. Please read the error message on the stud welding device for more information.

7.3 Technical data for PS-9(K) stud welding guns

Designation	<ul style="list-style-type: none"> • PS-9 stud welding gun (gap welding gun with lifting magnet) • PS-9K stud welding gun (contact welding gun)
Item no.	<ul style="list-style-type: none"> • PS-9: P01080 • PS-9K: P02160
Welding process	Capacitor discharge stud welding
Stud diameter	M3 - M8
Stud chuck	Adjustable and non-adjustable
Stud length	<ul style="list-style-type: none"> • Non-adjustable stud chuck up to a maximum of 45 mm • Adjustable stud chuck up to a maximum of 35 mm <p>Longer stud lengths possible with special accessories.</p>
Stud welding devices	<p>The gun is approved for operation on the following SOYER® stud welding devices:</p> <ul style="list-style-type: none"> • BMS-9 • BMS-9V
Weight	<ul style="list-style-type: none"> • PS-9: 2.7 kg including cable • PS-9K: 2.9 kg including cable
Subject to technical changes	

7.4 Cleaning of the stud welding gun

On a regular basis, remove slag and welding spatters from the gun and the support tube using a suitable tool.

The frequency of cleaning depends on the operating conditions of the stud welding gun.

CAUTION

Risk of injury during cleaning

Welding spatters and slag can be sharp-edged.

- Wear protective gloves when cleaning.



We recommend the use of SOYER® separating spray in order to prevent impurities from welding spatters and slag and to simplify the cleaning process.

8 Description of the PS-1K stud welding gun



Figure 4: PS-1K stud welding gun

Item	Designation
a	PS-1K stud welding gun, contact welding gun without lifting magnet
b	Support tube
c	Release button
d	Power and control cable for connection to the stud welding device

Due to a projection on the support tube and a spring in the gun, the stud of this gun is pressed firmly to the workpiece (contact gun).

The stud is not lifted before welding.



The PS-1K stud welding gun may only be operated with the stud welding devices specified in the technical data.



8.1 Technical data for PS-1K stud welding gun

Designation	PS-1K stud welding gun (contact welding gun)
Item no.	P02117
Welding procedure	Capacitor discharge stud welding
Stud diameter	M3 - M8
Stud chuck	Adjustable
Stud length	Adjustable stud up to a maximum of 35 mm. Longer stud lengths possible with special accessories
Stud welding devices	The gun is approved for operation on the following SOYER® stud welding devices: <ul style="list-style-type: none"> • BMS-6 ISO • BMS-8N • BMS-8NV • BMS-9 (*) • BMS-9V (*) • BMS-10N • BMS-10NV • BMS-10P
Weight	2.3 kg including cable
Subject to technical changes	

(*) With adapter plug, see technical data for the stud welding device.

8.2 Cleaning of the stud welding gun

On a regular basis, remove slag and welding spatters from the gun and the support tube using a suitable tool.

The frequency of cleaning depends on the operating conditions of the stud welding gun.

CAUTION

Risk of injury during cleaning

Welding spatters and slag can be sharp-edged.

- Wear protective gloves when cleaning.



We recommend the use of SOYER® separating spray in order to prevent impurities from welding spatters and slag and to simplify the cleaning process.

9 Description of the stud chuck

In principle, every welding gun is provided with a stud chuck that matches the welding stud. There are two types of stud chucks:

- Adjustable stud chucks
- Non-adjustable stud chucks

Corresponding to the stud diameter, stud chucks must be installed/changed in the gun.

In addition, adjustable stud chucks must be set to the stud length.

Please consult the technical data for the gun to ascertain the gun type that may be operated with a non-adjustable and/or an adjustable stud chuck.

9.1 Non-adjustable stud chucks



Non-adjustable stud chucks, as opposed to adjustable stud chucks, do not have to be set to the length of the weld stud.

Some SOYER® welding guns can be operated with non-adjustable stud chucks.





Correct application and triggering of the stud welding gun with weld stud is monitored by a safety switch in the stud welding gun. The welding process cannot be triggered when there is no stud in the stud chuck.

The installation of the stud chuck is shown using the example of the PS-9 gun. The installation of the stud chuck into other gun types is carried out in the same way.

Installing non-adjustable stud chucks

Step 1:	 <p>WARNING</p> <p>Switch off the stud welding device when the gun is connected to it.</p>	
Step 2:	Select the stud chuck according to the required stud diameter.	
Step 3:	<p>Remove the gun support tube.</p> <p> It is not mandatory to remove the support tube, however this makes use easier.</p>	

Installing non-adjustable stud chucks

Step 4:	Undo the union nut.	
Step 5:	If there is still a stud chuck in the gun, remove it.	
Step 6:	Slide the stud chuck up to the stop into the spring piston of the gun.	
Step 7:	Hand-tighten the union nut.	
Step 8:	Plug the support tube onto the gun.	
The assembly is complete.		

9.2 Adjusting and installing adjustable stud chucks

Adjustable stud chucks must be set to the length of the welding stud and, if necessary, to the gun size.

The standard stud chuck can hold studs with a length of up to 35 mm.





For welding guns with a short housing (e.g. PS-1K or PS-0K), it may be necessary to shorten the stop screw of longer welding studs.

When the adjusting screw is too long, the stud chuck cannot be fully inserted into the gun or the stud lift cannot be properly executed during welding.

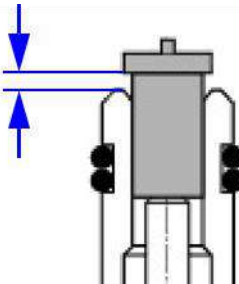

Adjusting the stud chuck

Adjusting adjustable stud chucks



Step 1:	Select the stud chuck according to the required stud diameter.	
Step 2:	Insert the stud into the stud chuck.	
Step 3:	<p>Adjust the stop screw so that the top of the flange of the stud sits between 1.5 mm and 3 mm above the stud chuck when it touches the screw.</p> 	

Step 4:	Fix the stop screw with the locknut.	
The adjustment is complete.		



Installing the stud chuck

The installation of the stud is shown using the example of the PS-9 gun. The installation of the stud chuck into other gun types is carried out in the same way.

Installing adjustable stud chucks

Step 1:	 <p>Switch off the stud welding device when the gun is connected to it.</p>	
Step 2:	Set the stud chuck to the required stud.	
Step 3:	<p>Remove the gun support tube.</p> <p>i It is not mandatory to remove the support tube, however this makes use easier.</p>	
Step 4:	Undo the union nut	
Step 5:	If there is still a stud chuck in the gun, remove it.	

Installing adjustable stud chucks

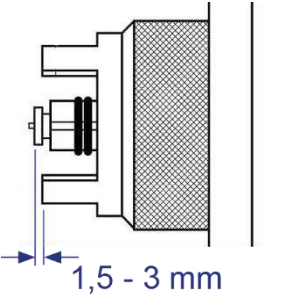
<p>Step 6:</p>	<p>Slide the stud chuck up to the stop into the spring piston of the gun.</p>	
<p>Step 7:</p>	<p>Hand-tighten the union nut.</p>	
<p>Step 8:</p>	<p>Plug the support tube onto the gun.</p>	
<p>Step 9:</p>	<p>Insert a stud and check the stud protrusion.</p> <p>The stud/stud flange must protrude 1.5 – 3 mm from the support tube.</p> <p>If applicable, correct the setting of the stud chuck (see chapter "Adjusting the stud chuck" on page 32).</p>	
<p>The assembly is complete.</p>		

10 Setup and connection

10.1 Requirements for the installation location

The installation location for the stud welding device must be clean and dry. Observe the permissible temperatures in chapter "6.4 Technical data for BMS-9(V) stud welding device" on page 20. Ensure that ventilation for the stud welding device is sufficient. Do not install the stud welding device in an unventilated room. There is a danger of overheating.

Ensure that the installation surface is flat, clean and stable.

The installation location and workplace must comply with legal requirements.

Ensure that the installation location has a good accessibility for maintenance work.

Make sure that the stud welding device cannot be soiled by dust (especially metal dust or chips) caused by work in the immediate surroundings (e.g. grinding work).

 **DANGER**



Danger from humid operation site or mobile use

There is a danger of electrocution when operating the stud welding device in a humid environment.

- The stud welding device must only be operated stationary and in closed and dry rooms. Mobile use is not permissible.

 **CAUTION**



Danger from welding vapours

Vapours that are dangerous to health may occur, depending on the material of the workpiece and/or the welding stud.

- Ensure suitable suction of welding vapours, if necessary.

10.2 Connection of the stud welding device and the stud welding guns

10.2.1 Mains connection

After installation, connect the stud welding device to the power supply using the mains plug. See chapter "6.4 Technical data for BMS-9(V) stud welding device" on page 20.

10.2.2 Connecting the earth cable

A secure earth connection must be established between the workpiece onto which the studs are welded and the stud welding device.

Plug the earth cable into the socket and turn the plug to the right up to the stop.

Then connect the earth cable to the workpiece (ensure a conductive connection).

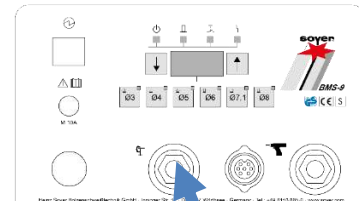

Then attach the earth clamps to the workpiece so that the welding gun is positioned in the centre of the connecting line of the two earth clamps. This guarantees a symmetrical current distribution around the stud as well as good welding results.

Difficult areas are weldings on the edge of the workpiece or great inhomogeneities in material thickness, i.e. the sheet thickness varies by a few millimetres or additional material is welded or riveted to the material. This also includes stud welding on vertical sections.

In order to achieve good welding results, carry out several test weldings under different conditions. Simply change the position of the earth clamps or turn the welding gun, for example.

You can determine the symmetry and quality of the arc during the preweld current test and afterwards optimise them by accordingly combining the earth connection and the gun position.

Arc blow effect

Blow effect due to earth connection or workpiece geometry

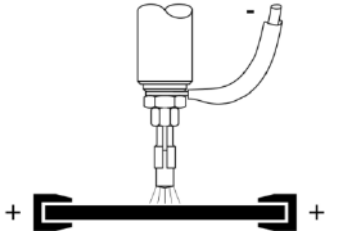
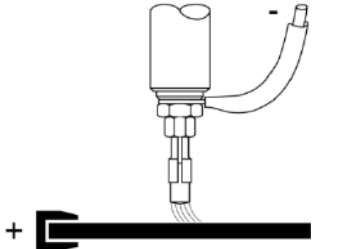
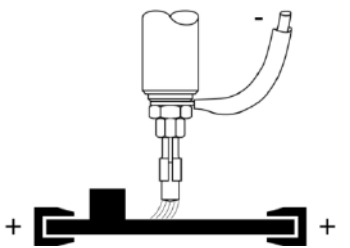
Blow effect	Explanation
	<p>Symmetrical earth connection Ideal condition, stud is located in the centre of the two earth connections.</p>
	<p>Asymmetrical earth connection The arc is deflected to the side where there is a lower current density.</p>
	<p>Workpiece geometry Additional workpiece masses disturb the arc symmetry.</p>

10.2.3 Connecting the stud welding gun

Only use the welding guns approved by the manufacturer. See chapter "6.5 Permitted stud welding guns" on page 21.

Plug the welding cable into the socket (a) and turn the plug to the right until stop.

Plug the control cable into the control cable socket (b) and tighten the union nut.

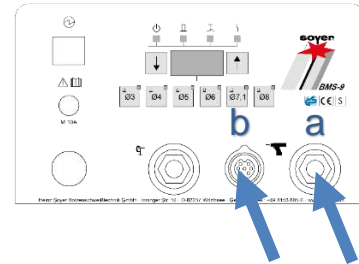

The gun type is automatically recognised by the stud welding device. Check whether the connection of the gun requires any special adapters (see chapter "6.5 Permitted stud welding guns" on page 21).

11 Settings

The stud welding device and gun must be matched and adjusted for the respective work.

11.1 Adjusting the charging voltage and lift time on the stud welding device

In the following, it is described how the charging voltage and lift time/height of lift are adjusted.

In order to achieve an optimal stud welding result, carrying out some test welds with different settings is necessary.

Adjustment of the lift time refers only to special gap welding guns with lifting magnets (not the contact welding guns with type designation "-K").

The charging voltage to be set on the stud welding device depends, among other things, on the following influencing factors:

- Material of the workpiece
- Thickness of the workpiece
- Material of the welding stud
- Diameter of the welding stud

11.1.1 Device adjustment tables

The values given in the following tables can be useful as guide values for an initial sample weld.

Charging voltage

Information on the stud diameter (\emptyset) is shown on the front panel of the stud welding device. This enables fast preselection of the charging voltage. The corresponding threaded stud is indicated in the tables on the following page.

After the preselection key has been pressed, the values for the charging voltage indicated in the tables are displayed on the welding device. The values can be changed with the $\uparrow\downarrow$ arrow keys.



The preselection keys show proposal values for a charging voltage which, from experience, is approximately that required for welding a stud with the selected diameter. This value is a reference value that has to be modified with the arrow keys when carrying out test weldings.

The value adjusted with the arrow keys is saved even after switching the device off. It remains unchanged until a new value is entered.



Lift time

Additionally, empirical values for the adjustment of the lift time can be found in the tables below (see chapter "11.1.3 Adjusting the lift time (height of lift) in the "Setup" mode"

BMS-9 adjustment table / adjustment aid

Device key Ø [mm]	Ø3	Ø4	Ø5	Ø6	Ø7.1	Ø8
Corresponds to a threaded stud	M3	M4	M5	M6	-----	M8
Preset charging voltage [V]	70	100	115	140	175	195
Reference value for lift time [ms]	With PS-9 gun: 6 - 7 ms					
Reference value for lift time [ms]	With PS-3 gun: 9 - 10 ms					

BMS-9V adjustment table / adjustment aid

Device key Ø [mm]	Ø4	Ø5	Ø6	Ø7.1	Ø8	Ø10
Corresponds to a threaded stud	M4	M5	M6	-----	M8	M10
Preset charging voltage [V]	65	80	95	120	180	195
Reference value for lift time [ms]	With PS-9 gun: 6 - 7 ms					----(*)
Reference value for lift time [ms]	With PS-3 gun: 9 - 10 ms					----(*)

(*) No lift time as this diameter can only be welded with a contact welding gun (PS-3K Stativ).

11.1.2 Adjusting the charging voltage

The charging voltage has been preset (see chapter "11.1.1 Device adjustment tables" on page 39). A value for the charging voltage is proposed depending on the selected diameter and gun type recognised by the device.

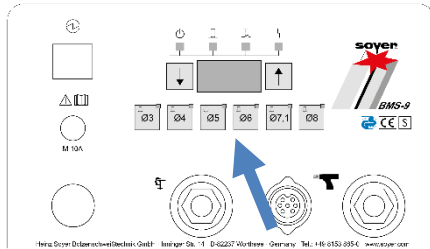
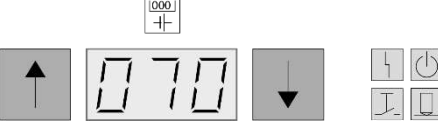
Step 1:	Connect the device as described in chapter "10.2 Connection of the stud welding device and the stud welding guns" on page 36.	
Step 2:	Preselect the required stud diameter.	
Step 3:	A value for the charging voltage in [V] is shown on the display. The value may be increased or decreased by pressing the arrow keys ↑↓.	
<p>The charging voltage is adjusted.</p> <p>i</p> <p>The set value is saved and remains unchanged after the device has been switched off and back on again.</p>		

11.1.3 Adjusting the lift time (height of lift) in the "Setup" mode

Adjustment of the height of lift/lift time refers only to special gap welding guns with lifting magnets (not the -K types). For these guns, the stud is lifted for a defined height/time just before the welding process and is then automatically lowered during the welding process.

As the height of lift of the stud is difficult to measure, the equivalent lift time is specified on the stud welding device.

In the following setting of the lift time, the welding process is simulated in the "Setup" mode. The lifting and lowering of the stud is the same as during welding, only the welding current is not activated.

Operating modes

- Setup mode: No welding is carried out when simulating a welding process.
- Operating mode (normal mode): Welding is carried out.



Danger from incorrect operating mode





If the following adjustment work is not carried out in the "Setup" mode but in the operating mode, a weld is carried out by pressing the release button on the gun.

- If a contact welding gun (K type) is connected when the "Setup" mode is started, "Con" is shown on the display for approx. 3 seconds and the normal mode starts automatically. There are no lifting magnets for contact welding guns.
- If the control plug of the gun is disconnected during the lifting test, the device displays "Con" for approx. 3 seconds and automatically starts the operating mode.
- You are in the operating mode when no gun type is not shown on the display after switching over to the "Setup" mode.

Adjusting the lift time/height of lift

Step 1:	Connect the device as described in chapter "10.2 Connection of the stud welding device and the stud welding guns" on page 36.
Step 2:	Check that the stud welding device is switched off.
Step 3:	Insert a welding stud into the gun.

Adjusting the lift time/height of lift

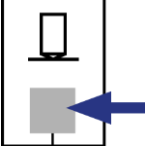
<p>Step 4:</p>	<p style="text-align: center;">Activating the "Setup" mode</p> <p>To activate the "Setup" mode, press down the $\uparrow\downarrow$ keys and switch on the stud welding device at the same time.</p> <p>Keep the arrow keys pressed down until "L- -" is shown on the display.</p> <p> "66" or "99" is shown on the display if an incorrect key combination was pressed. To reset the error, switch the device off and on again using the main switch.</p> <div style="display: flex; justify-content: space-around; align-items: center;">    </div>
<p>After approx. 1 second the gun type recognised by the device is shown on the display.</p> <p>WARNING</p> <p>"Setup" mode is only activated when</p> <ul style="list-style-type: none"> - the gun type is shown on the display - the ready indicator lamp does not light up  and - no stud preselection is lit. <p>A gap welding gun with lifting magnets not recognised as being PS-9 is automatically shown as being a PS-3 gun.</p> <p>If all three criteria are not satisfied, you are in the operating mode and a weld is carried out the next time the release button is pressed.</p>	
<p>Step 5:</p>	<p>Place the gun on the workpiece and press the release button on the gun for the weld.</p> <div style="text-align: right;">  </div> <p>Make sure the "Stud on workpiece" blue control lamp lights up before triggering.</p> <p>The currently set value for the lift time in [ms] appears on the display. The longer the lift time, the higher the height of lift. Determining the correct lift time requires experience and some trials. Guide values for the correct lift time can be found in chapter "11.1.1 Device adjustment tables" on page 39.</p> <p>The lift time is changed using the adjustment ring on the welding gun for the height of lift of the stud.</p>
<p>When the required lift time is set, switch off the stud welding device and then back on again. The device is then back in the operating mode.</p>	

Notes on "Setup" mode

- The setup process can be repeated as often as required. However, to avoid the magnetic coil overheating, maintain a waiting time of approx. one second between test strokes.
- If the lifting cycle is carried out without the message that the stud is on the workpiece, then [- -] is shown instead of the lift time as there was no earth connection.

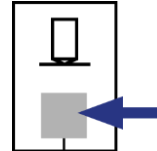

12 Welding operation

In the following, it is described how weldings are carried out and how possible welding errors can be avoided.

12.1 Carrying out welding

In the following, it is described how weldings are carried out with a stud welding gun.

 DANGER
<p>Danger from incorrect operation</p> <p>During stud welding, incorrect operation of the devices may cause many dangers.</p> <ul style="list-style-type: none"> • Before using the stud welding device, see chapter "2. Important safety instructions" on page 8. • If you have any problems understanding the operating instructions, contact the manufacturer, Soyer.

Carrying out welding

Step 1:	Before welding, see chapter "2. Important safety instructions" on page 8.
Step 2:	Connect the gun to the stud welding device (see chapter "10.2 Connection of the stud welding device and the stud welding guns" on page 36). Check if a connection adapter may be required.
Step 3:	Insert the appropriate stud chuck and a welding stud (see chapter "7. Description of the PS-9(K) stud welding guns" on page 23, chapter "8. Description of the PS-1K stud welding gun" on page 27 and chapter "9. Description of the stud chuck" on page 30). Only use SOYER® welding studs.
Step 4:	Check the charging voltage and lift time/height of lift (see chapter "11.1 Adjusting the charging voltage and lift time on the stud welding device" on page 39).
Step 5:	Ensure that the welding points on the stud and workpiece are metallically bright.

Carrying out welding

Step 6:	<p>Press the gun onto the workpiece at an angle of 90°.</p>  <p>When using a contact gun, press it firmly against the spring force.</p>
Step 8:	<p>Press the release button of the gun.</p> <p>Welding is carried out.</p> <p>i</p> <p>During the welding process, hold the gun steadily and only remove it vertically from the welded stud after the welding process is finished. By doing so, widening or damaging the stud chuck is avoided.</p>
The welding process is finished.	

12.2 Notes on checking the quality of the weld

If the SOYER® stud welding equipment is handled correctly and the correct materials are selected, the strength of the welding joint (welding zone) is always higher than the strength of the stud or the base material.

In practice, the following production control tests have proved successful:

- Visual inspection
- Bend test

Further information, see standard:

DIN EN ISO 14555 Arc stud welding of metallic materials or Technical Bulletin DVS 0904 Instruction for practice - Arc stud welding.

12.2.1 Visual inspection

The visual inspection serves as a rough check for major defects. The uniformity of the weld is assessed. The following table serves as an aid for the assessment of the welding result:

Visual inspection

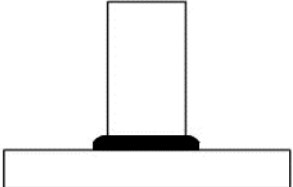
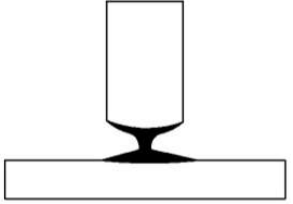
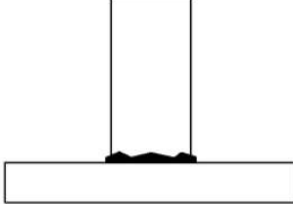
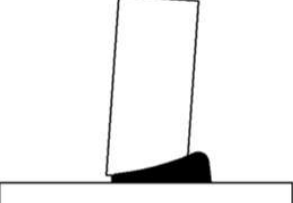
Welding image	Note
	<p>Good welding joint. Optimum setting.</p> <p>Even, bright and closed welding bead.</p>
	<p>Poor welding joint, e.g. because the welding energy is too high or the immersion distance / lift is too small.</p> <p>The stud is constricted to the welding joint. The stud is only partially welded.</p>
	<p>Poor welding joint, e.g. because the welding energy is too low or the lift is too short.</p> <p>The welding bead is weak and unevenly formed.</p>
	<p>Poor welding joint, e.g. due to a blow effect or a welding gun that was shaken or applied at a slant.</p> <p>The stud flange is not welded completely and has visible imperfections. Undercuts are visible.</p>

12.3 Switching off the device

Switch off the stud welding device at the mains switch.

The connected welding gun is switched off automatically.

Ensure that the stud welding device cannot be switched on and used by unauthorised persons.

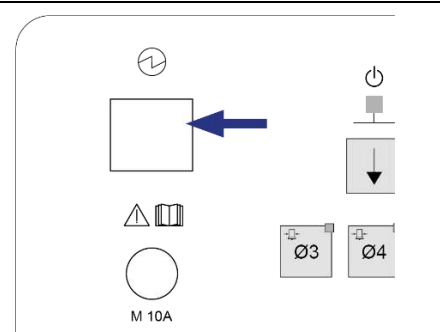

12.4 Welding defects and their causes

In the following, the most common welding errors, possible causes and troubleshooting are described.

Please contact Heinz Soyer Bolzenschweißtechnik GmbH if a problem cannot be solved.

Error	Possible cause and troubleshooting
System does not weld, no sparking	Stud welding device is not switched on. <ul style="list-style-type: none"> • When switching on the device, the blue pilot lamp "Ready" must light up.
	Welding points or earth connection points on the workpiece are not metallically bright. LED display "Stud on workpiece" does not light up (see chapter "6.3.1 Displaying the operating states" on page 19). <ul style="list-style-type: none"> • Prepare the workpiece or studs. Grind connection points to a bright metal finish.
Scorched stud thread	The stud is too loose in the stud chuck. <ul style="list-style-type: none"> • Press or retighten the stud chuck.
	Stud chuck is worn. <ul style="list-style-type: none"> • Exchange stud chuck.
Varying welding results with unchanged settings	Stud is too loose or not fully inserted into the stud chuck. <ul style="list-style-type: none"> • Insert stud until stop. • If necessary, exchange the stud chuck.
	Welding studs manufactured inaccurately. <ul style="list-style-type: none"> • Use only SOYER® weld studs.
Stud is not welded to the whole flange surface, strength of the welding is insufficient	Excessive soiling of the workpiece surface. <ul style="list-style-type: none"> • Clean or grind the surface of the workpiece to a bright metal finish.
	The front surface of the welding stud is deformed. <ul style="list-style-type: none"> • Use new welding studs. • Only use SOYER® welding studs.
	The welding gun was placed in tilted position. <ul style="list-style-type: none"> • Position the welding gun evenly.

12.5 Malfunctions with an error message

DANGER

Danger during troubleshooting

During troubleshooting, various dangers may occur.

- All devices of Soyer Bolzenschweißtechnik GmbH may only be opened by personnel of Soyer or personnel authorised by Soyer.
- For troubleshooting, the device must be disconnected from the main power supply and secured against accidental switch-on.

When there is a stud welding device malfunction, an error message (code) appears on the display.

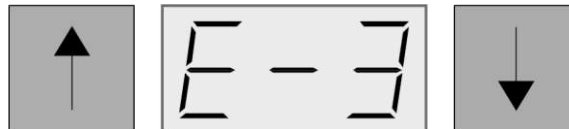

Code	Description	Possible cause
E01	Safety shutdown as a voltage of more than 25 V was measured for more than approx. 40 ms on the welding power sockets.	<ul style="list-style-type: none"> Stud inserted too deep in the stud chuck Mechanical problems with the gap welding gun External voltage of other stud welding devices Error in the device (thyristor short circuit)
E02	Error when charging the capacitors	<ul style="list-style-type: none"> Welding capacitors faulty (leakage current) Charging current source faulty
E03	Safety circuit malfunction	<ul style="list-style-type: none"> Defective quick-discharging resistor Safety relay is clamping or sticking Switching times of the safety relay too long
E05	Incorrect mains voltage	The mains voltage must be between 90...130 V or 180...275 V at 50...60 Hz. The device automatically recognises both ranges.
E05	Excess temperature of the electronic equipment	During high welding sequences, the device may be exposed to an increased ambient temperature (>45°C) or direct sunlight.

Code	Description	Possible cause
E06	Error in the welding gun	<ul style="list-style-type: none"> • Non-permissible welding gun • Welding gun incorrectly wired • Wrong adapter on the gun cable
E07	Short-circuit in the magnetic circuit	Defective gun cable or magnetic coil.
66	No valid key combination pressed	Wrong keys or keys not correctly pressed. Error reset by switching the device off and then on again.
99	No valid key combination pressed	Wrong keys or keys not correctly pressed. Error reset by switching the device off and then on again.

Notes on error messages

- In case of errors E01 to E04, E06 and E07, the device switches to malfunction. Welding is no longer possible. The device can only be recommissioned when it is switched off and then switched on again.
- In the event of error code E05, excess temperature, the welding device cannot be used until the displayed error message disappears.
- If the device operates with reduced charging current due to high internal temperatures, the "Malfunction" LED flashes.



13 Maintenance and repair

Maintenance and repair of the stud welding device and the stud welding gun must only be performed by Heinz Soyer Bolzenschweißtechnik GmbH or authorised specialists.

14 Service

If servicing is required, please contact:

Heinz Soyer Bolzenschweißtechnik GmbH

Inninger Straße 14

82237 Wörthsee

Tel.: 0049-8153-885-0

Fax: 0049-8153-8030

Mail: info@soyer.de

Please have the serial number at hand during service requests.

Alternatively, you can contact your respective Soyer agent. Contact information can be found on our website at

www.soyer.de or
www.soyer.com (English)

15 Warranty conditions

The warranty period for commercial or equal use is 12 months. If repair is required, we guarantee the correction of the defects at the Etterschlag plant. Wearing parts are excluded.

The warranty claim shall expire if damage is caused through improper operation, repairs or interventions are undertaken by unauthorised persons and accessories and spare parts are used that are not intended for our system.

When using welding studs from external manufacturers, we do not assume any warranty for proper function of the stud welder and the quality of the welding joint.



Heinz Soyer Bolzenschweißtechnik GmbH

Inninger Straße 14
82237 Wörthsee
Tel.: 0049-8153-885-0
Mail: info@soyer.de
www.soyer.com

