

# Operating Instructions BMK-12i

Stud welding inverter for drawn arc welding  
with SRM technology



**SRM**TECHNOLOGY®  
*Made by SOYER*

GB: English Version

Read these operating instructions before starting any work!



CE





# Operating Instructions

## BMK-12i Stud Welding Inverter

Serial number\*

BMK-12i stud welding inverter

---

Please enter the serial number here, so that the data is available if you need service support.

Order No.	Code designation	Note
P01360	BMK-12i	Mains voltage 3 x 400 V

### Heinz Soyer Bolzenschweißtechnik GmbH

Inninger Straße 14 | 82237 Wörthsee | Tel.: +49 8153 8850 | Fax: +49 8153 8030 | E-mail: info@soyer.de | www.soyer.de



Thank you!

Congratulations on purchasing the BMK-12i SOYER® stud welding inverter. You have made an excellent choice. Your BMK-12i SOYER® stud welding inverter was specially developed for the high-speed fastening of **SOYER® HZ-1** weld studs on metallic, weldable workpieces by means of the patented **SRM technology**. The welding inverter also allows weld studs in compliance with DIN EN ISO 13918 to be welded on metallic, weldable parent material.

**Our devices have been tested and proven according to current European and national guidelines on health and safety. Proof of conformity has been established and the manufacturer is in possession of the corresponding documents.**



#### **FOR YOUR SAFETY**

Read all of these operating instructions prior to start-up. Please follow all safety precautions as well as all chapters of these operating instructions before starting to weld. Non-compliance with the safety precautions can result in serious personal injuries or death.

SOYER® is a registered trade mark of Heinz Soyer Bolzenschweißtechnik GmbH.

It is prohibited to distribute or reprint this document. It is also prohibited to exploit or disclose its contents unless permission has been expressly granted. Non-compliance with this regulation will lead to compensation for damages. All rights reserved, particularly in the case of a patent grant or a GM registration.

We have verified that the contents of this pamphlet correspond to the hard- and software described. Deviations, however, cannot be excluded so that we cannot warrant for absolute compliance. The illustrations contained in this instruction manual can vary in some details from your product. This, however, has no influence on the handling of the machine.

The data in this documentation is verified regularly and any necessary corrections incorporated in future impressions. Any suggestions for improvement are appreciated.

Date of issue: August 10, 2017  
Rev.1 (Update Declaration of Conformity)

© Heinz Soyer Bolzenschweißtechnik GmbH 2017 · All rights reserved

Printed in the Federal Republic of Germany

**Heinz Soyer Bolzenschweißtechnik GmbH  
Inninger Straße 14  
82237 Wörthsee**

CE Declaration of Conformity

We herewith declare that the machine described in the following and the version available on the market correspond in design and construction to the safety and health requirements of the listed guidelines and standards. Any unauthorised modification to this machine automatically annuls this declaration.

Designation of machine	:	<b><u>Stud welding device</u></b>
Machine type	:	<b><u>BMK-12i</u></b>
Machine no.	:	_____
Applicable EU directives	:	RoHS Directive (2011/65/EU) Low Voltage Directive (2014/35/EU) EMC Directive (2014/30/EU)
Applied harmonised standards, in particular	:	EN 60 974-1:2012 EN 60 974-10:2008
Applied national standards	:	DGUV Regulation 1
Date	:	03 August 2017
Producer's signature	:	 _____
Signer's function	:	Managing Director



## Table of contents

<b>1</b>	<b>Safety instructions</b> .....	<b>8</b>
1.1	Description of reference signs in the operating instructions .....	10
1.2	Staff qualification and training.....	11
1.3	Dangers in the case of non-compliance with safety instructions .....	11
1.4	Before starting to weld... ..	11
1.5	Working with the stud welding inverter .....	11
1.6	Inadmissible operating methods .....	11
1.7	Stopping the welding equipment.....	11
<b>2</b>	<b>General</b> .....	<b>12</b>
2.1	The following should be principally observed... ..	12
2.2	Intended use .....	12
2.3	Marketing and service.....	13
2.4	Information on the documentation .....	13
2.4.1	Information on the operating instructions .....	13
2.4.2	Conduct in the case of malfunctions.....	13
<b>3</b>	<b>Description of welding equipment</b> .....	<b>14</b>
3.1	Description .....	14
3.2	Stud welding in a radially symmetric magnetic field (SRM Technology) .....	14
3.2.1	Drawn arc stud welding technology using shielding gas .....	15
3.3	Technical data.....	16
<b>4</b>	<b>Start-up</b> .....	<b>17</b>
4.1	Installation of equipment .....	17
4.2	Front and rear view .....	18
4.2.1	Operating elements .....	19
4.2.2	Description of the display unit.....	19
4.2.3	Description of the operating modes and parameters.....	20
4.2.4	Overview of menu items .....	22
4.2.5	Description of symbols.....	23
4.3	Preparation for start-up .....	24
4.3.1	Earth connection.....	24
4.3.2	Connection of stud welding gun.....	25
4.4	Preparation of gas supply .....	25
4.4.1	Gas supply.....	26
4.4.2	Power supply .....	27
4.5	Starting the welding equipment.....	27
4.6	Test modes.....	27
4.6.1	Operating mode "Pre-Weld Current Test" .....	27
4.6.2	Operating mode "Lift Test".....	28
4.6.3	Operating mode "Gas Test" .....	29
4.7	Welding parameters .....	29
<b>5</b>	<b>Operation</b> .....	<b>31</b>
5.1	Brief description .....	31
5.2	Basic setting of the SRM stud chuck .....	33
5.3	Basic setting of the SRM nut holder.....	34





---



5.4	<i>Start-up of the PH-9 SRM stud welding gun</i> .....	36
5.5	<i>Notes on the "Lifting test" operation mode</i> .....	41
5.6	<i>SRM welding operation</i> .....	41
5.6.1	<i>Stud welding with shielding gas</i> .....	42
5.7	<i>Error messages and notes</i> .....	43
5.7.1	<i>Gun connection</i> .....	43
5.7.2	<i>Increased temperature</i> .....	43
5.7.3	<i>Excessive temperature</i> .....	43
5.7.4	<i>Phase failure / overvoltage / undervoltage</i> .....	44
5.7.5	<i>Error code table</i> .....	44
<b>6</b>	<b>Quality control (stud welding)</b> .....	<b>44</b>
6.1	<i>General instructions</i> .....	44
6.2	<i>Test execution</i> .....	45
6.2.1	<i>Production of samples</i> .....	45
6.2.2	<i>Visual inspection</i> .....	45
6.2.3	<i>Bend test</i> .....	46
<b>7</b>	<b>Maintenance</b> .....	<b>47</b>
7.1	<i>Important instructions</i> .....	47
7.2	<i>Important instructions for all service works</i> .....	47
7.3	<i>Cleaning</i> .....	47
7.3.1	<i>Detergents for cleaning the housing</i> .....	47
7.4	<i>Replacement of components</i> .....	48
<b>8</b>	<b>Troubleshooting</b> .....	<b>48</b>
8.1	<i>Malfunctions</i> .....	49
<b>9</b>	<b>Transport and storage</b> .....	<b>52</b>
<b>10</b>	<b>Terms of warranty</b> .....	<b>52</b>
<b>11</b>	<b>List of standards and guidelines</b> .....	<b>53</b>



# 1 Safety instructions

These safety precautions are for your safety.

	<b>General safety instructions</b> Take part in a training programme. Read and follow all safety precautions listed below and all chapters of this manual <u>before starting to weld</u> . <b>Non-compliance with the safety precautions can result in personal injuries or death.</b>
	Only qualified persons are allowed to operate and maintain the equipment.  Children and juveniles under the age of 16 years must be kept away from the equipment.

	<b>WARNING</b> <b><u>It is prohibited to open the stud welding equipment.</u></b> The service personnel are required to meet special qualifications. Our after-sales service has adequately trained personnel, suitable service equipment and the means to carry out all necessary works.
---	--

	<b>Warning of electromagnetic fields</b> Keep sufficient distance from electronic devices. When stud welding, highly intensive electromagnetic fields are created which may permanently damage these devices (e.g. television sets, airbags).
	Ensure that the welding equipment is not operated near electronically sensitive life-support equipment, such as in intensive care units in hospitals.  Persons with pacemakers may neither operate the stud welding equipment nor stay in the immediate vicinity while it is running.

	<b>Electric shock can cause death</b> Prevent electric shock by insulating your body from the working area and the ground. Stand on dry insulating material and wear rubber soled shoes.
	Inspect all cables including power cord for damage, wear or bare wiring.  Always ensure the correct supply voltage in accordance with the type plate. <u>Never</u> connect the welding equipment to a power supply network with incorrect supply voltage.  <u>Always</u> disconnect the welding equipment from the mains supply before starting any cleaning works. Only trained and appropriately qualified personnel are allowed to carry out works at the electric mains supply and welding system.  Do not touch live electrical parts with bare hand. Wear dry, hole-free insulating gloves.  Do not wear rings, watches or electrically conductive jewellery.  Keep the work area, studs, guns, cables, energy source as well as your clothes dry.



**Fumes and gases can cause damage to your health**

Fumes and suspended/floating particles may be generated during welding. Beware of fumes detrimental to health, particularly when using surface treated materials. Please also observe the safety regulations applicable for your country.

Do not inhale fumes and gases. Use adequate ventilation in the work area to remove fumes and gases.

**Welding can cause fire and explosions**

Welding sparks and heat from flames and arcs can cause fires. Keep a portable fire extinguisher within reach for immediate use. Be sure you are trained to use it.

When welding, do not wear clothes soiled with easily combustible substances such as oil, grease and paraffin oil etc.



Comply with the fire regulations and do not weld, for instance, in hazardous locations.



Pay attention to flammable objects at the welding place. All flammable materials and liquids, such as oil, fuel, etc. must be removed prior to the start of work.

Electronic equipment (e.g. airbags) and the use of explosive substances for fuel supply require further safety precautions when carrying out welding operations on cars. Appropriate information can be obtained from the trade associations or the car manufacturers.

**Skin and eye protection**

Arc rays and welding spatters can injure eyes and skin.

Wear safety glasses with side shields and protective goggles with correct shade of filter to protect your eyes from welding spatters and flashes of light that are generated during the welding process.



Wear gauntlet gloves made of leather as well as non-combustible closed working clothes such as heavy long-sleeve shirts, cuffless pants and safety shoes.



Wear a leather apron to protect your clothes from welding spatters. Keep sleeves and collars buttoned and remove open pockets from the front side of your clothing.





We recommend using ear protection. Some welding and working processes may generate loud noises.

## 1.1 Description of reference signs in the operating instructions

















The non-observance of safety instructions such as pictographs and warning words can cause damage to persons. The safety instructions of this operating manual describe the following.

### Safety instructions

	Danger!	Immediate hazards which could result in serious personal injuries or loss of life.
	Warning!	Potential hazards which could result in serious personal injuries or loss of life.
	Caution!	Potential hazards which could result in minor personal injuries.
	Caution!	Warning of damage.
	Note!	Potential detrimental situation which may cause damage to the product or to an object surrounding it.
	Important!	Instructions for application and other useful information facilitating the proper use of the product.

### Safety symbols

The following pictographs for warnings, prohibitions and regulations are used in this manual:

 Prohibited for persons with pacemakers	 Prohibited (only in combination with an additional safety symbol)	 Do not touch Housing is current-carrying	 Fire extinguisher
 Warning of a danger spot	 Warning of dangerous electric voltage	 Warning of electromagnetic field	 Warning of moving parts
 General prohibition (only in combination with an additional safety symbol)	 Warning of inflammable substances	 Warning of explosive substances	
 Eye protection required	 Protective clothing required	 Ear protection required	 Protective gloves required
 General instructions are marked with the hand symbol.			

## 1.2 Staff qualification and training

The staff responsible for operation, maintenance, inspection and assembly must have the respective qualification for carrying out these works. Field of responsibility, competence and the supervision of staff must be carefully regulated by the user. If your personnel do not have the necessary knowledge, they must be trained and instructed. If necessary, this can be done by the manufacturer/supplier on behalf of the user. Furthermore, the user must ensure that the contents of the operating instructions have been fully understood by the staff.

The society of welding institutes (GSI: Gesellschaft der Schweißtechnischen Institute mbH) offers the appropriate training courses for your personnel.

For information on branches, please refer to website <http://www.dvs-ev.de>.

## 1.3 Dangers in the case of non-compliance with safety instructions

The non-compliance with safety instructions may not only endanger persons, but also the equipment and its environment. Any non-compliance with safety instructions may result in a complete loss of damage claims.

The following dangers may result if the safety instructions are not complied with:

- Failure of important system functions
- Failure of prescribed methods for maintenance
- Danger to persons through electrical, mechanical, thermal and/or acoustic influences.

## 1.4 Before starting to weld...

- Check the state of all cables and cable connections before starting to weld.
- Immediately replace defective cables and cable connections.

## 1.5 Working with the stud welding inverter

Comply with all accident prevention regulations applicable to the operation of your welding equipment. If an accident happens,

- switch off the welding equipment and disconnect it from the mains supply and
- call a doctor

## 1.6 Inadmissible operating methods

*Limit values*

*The working safety of the stud welding equipment is only guaranteed when the system is used in accordance with its purpose. The limit values indicated in the chapter "Technical data" must never be exceeded.*

## 1.7 Stopping the welding equipment

- Turn off the mains switch of the stud welding equipment.
- Disconnect the mains plug from the mains socket.
- Disconnect welding gun from the welding equipment.
- Disconnect the earth cable from the welding equipment.
- Roll up the cables without buckling them.
- Prevent the welding equipment being operated by unauthorized personnel.
- Check welding cables and connections of the welding equipment for damage such as burn-off, mechanical wear etc. and have damaged parts replaced by the SOYER® customer service.



## 2 General

### 2.1 The following should be principally observed...

With the BMK-12i stud welding inverter you have purchased a product which

- is state-of-the-art technology
- fully complies with the current safety requirements
- features a unique compact design
- ensures high performance.

Before installing the welding equipment, please observe the following:

- Store the operating instructions in a place accessible to every operator.
- Ensure that the respective operator has read and understood the operating instructions prior to start-up. Each operator should confirm this per signature.
- Prevent the welding equipment being operated by unauthorized personnel.
- Only trained personnel may operate the welding equipment.

	<b>CAUTION - Hazards due to wrong gun</b> Hazards for the operator can arise if the wrong welding gun is used. <ul style="list-style-type: none"><li>• Only use the welding guns from Soyer permitted in the following.</li></ul>
--	--

	<b>NOTE</b> The use of other guns or guns from another manufacturer will invalidate the declarations of conformity and the warranties of Soyer.
---	--

### Overview of permitted stud welding guns

Gun	Comments
PH-9 SRM <sup>12</sup>	Standard gun
PH-9 SRM <sup>12</sup> +G	Standard gun
PH-3N SRM	Connection adapter required (1)

(1): Possible with optional adapter plug and adapter cable.

Adapter plug for the gas connection: F06695/FA  
Adapter cable for the control cable: F06694/FA

### 2.2 Intended use

The BMK-12i SOYER® stud welding inverter allows you to weld pins and threaded studs from M3 – M12 or Ø 2 - 11 mm and many other types of weld fasteners manufactured from steel, stainless steel and aluminium.

If you need consultation or assistance in solving problems, please contact either our parent company or our field engineers.

## 2.3 Marketing and service

If you have any questions regarding the operation, retrofits for special applications or if you require service, please contact your responsible service office or the following address:

### Heinz Soyer Bolzenschweißtechnik GmbH

Inninger Straße 14  
D-82237 Wörthsee  
Telephone +49 8153 8850  
Telefax +49 8153 8030  
[www.soyer.de](http://www.soyer.de)  
[info@soyer.de](mailto:info@soyer.de)

## 2.4 Information on the documentation

The following operating instructions are supplied with the BMK-12i stud welding inverter:

- Operating instructions for BMK-12i **Order No.:** P00256

### 2.4.1 Information on the operating instructions

#### *Legal relationship*

We point out that the contents of these operating instructions are neither part of any former or existing arrangement, pledge or legal relationship nor have they been designed to modify the latter. All obligations of Heinz Soyer Bolzenschweißtechnik GmbH result from the respective contract of purchase. This contract also contains the complete and universally valid warranties. These contractual warranty terms are neither extended nor restricted by the implementation of these operating instructions.

	<b>CAUTION</b> Do not carry out any actions on the stud welding equipment without specifically knowing the operating instructions or the respective part. Ensure that only qualified and trained personnel familiar with the operating instructions operate the system.
---	--

### 2.4.2 Conduct in the case of malfunctions

If malfunctions occur, first try to detect and eliminate the causes according to the list in the "Troubleshooting" chapter of these operating instructions. In all other cases, contact our service department.

If you require our service, please make sure that you supply us with the following information:

- Customer number
- Product designation / options
- Serial number
- Year of construction
- Material of stud and workpiece
- Stud dimensions

This information helps us save time and unnecessary costs, e.g. incurred by delivering the wrong spare parts.



## 3 Description of welding equipment

### 3.1 Description

The BMK-12i stud welding inverter has been designed for mobile use. As a result of intensive development work in the area of inverter technology, the SOYER<sup>®</sup> BMK-12i defines a completely new equipment class. The equipment operates on the basis of a compact inverter source of electricity and provides constant welding currents up to 800 A with extremely short welding periods. Here, the rectified mains voltage is converted into a high-frequency voltage with a frequency of 100 kHz via an inverter on a MOSFET basis. The electrical current is transferred via a high-frequency transformer and is rectified on the output side. As a result of the high control rate in connection with the integrated SRM welding procedure of the BMK-12i, the reproducibility of the weld is increased and the quality significantly improved.

The equipment offers the possibility to store the parameters for different welding tasks as welding programs and to call them up again at any time. In order to simplify the operation, programs for different stud diameters can be saved. This enables a simple and rapid switching between different welding tasks.

The equipment comprises four push-buttons as well as a full graphic display with intuitive menu navigation on its front panel. The settings are made via the push-buttons. The operating status during the welding process is indicated on the display.

The following stud welding procedures are supported by the equipment:

- Stud welding in a radially symmetric magnetic field (SRM)
- Drawn arc (DA) stud welding with inert gas
- Short-cycle (SC) drawn arc stud welding (without inert gas and without ceramic ring)

The PH-9 SRM stud welding gun with control cable and SRM inert gas equipment should be connected to the BMK-12i stud welding inverter as standard gun. This operating manual exclusively describes the BMK-12i stud welding inverter. Information regarding the stud welding guns to be used as well as their setting can be obtained from the respective operating manuals of the stud welding guns.

### 3.2 Stud welding in a radially symmetric magnetic field (SRM Technology)

For operating the BMK-12i stud welding inverter, we recommend using the patented SRM stud welding process (patent no. 10 2004 051 389) in conjunction with the newly developed HZ-1 universal weld stud featuring a plane end face and centring tip (patent no. 10 2006 016 553). This innovative welding technique enables welds at a ratio of 1:10 from the sheet thickness to the stud diameter (previously 1:4). Furthermore there is no need to use ceramic rings during this process. The numerous advantages delivered by the SRM procedure offer completely new potential applications in the entire field of stud welding technology (for additional information, please refer to [www.hz-1.com](http://www.hz-1.com)).

Further benefits of SRM welding include:

- No disturbing weld bead
- No ceramic ferrule required even in constrained positions (out-of-position welding)
- Reduced penetration in the sheet
- Less energy consumption and shorter welding time
- No weld spatters

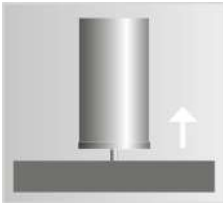
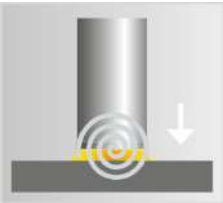
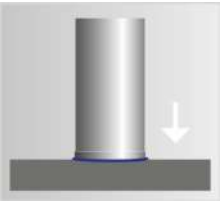
		
<p>The stud comes into contact with the workpiece and is raised. The arc is triggered.</p>	<p>The arc is guided through the spiral-shaped magnetic field and fully melts both join parts.</p>	<p>The stud immerses into the very flat penetration zone and is inseparably connected.</p>

The above illustration shows the radially symmetric magnetic field stud welding process (SRM).

With this welding process, we recommend using the following inert gases:  
 gas mixture containing 82% of Argon and 18% of CO<sub>2</sub> or gas mixture containing 90% of Argon and 10% of CO<sub>2</sub>.

### 3.2.1 Drawn arc stud welding technology using shielding gas

With this method, a gas mixture containing 82% of Argon and e.g. 18% of CO<sub>2</sub> (e.g. Corgon®18\*) is used as auxiliary aid. This shielding gas protects the welding point from the atmosphere and simultaneously supports the weld pool. Moreover, it ensures a concave fillet weld upset formation with a blank metallic surface, thus reducing the risk of corrosion and obtaining an improved dynamic behaviour of the welded joint.

An accurate bulging, to scale or in a calibrated or reproducible type, is not possible when welding with shielding gas without using any auxiliary aid. Stud welding with shielding gas can be carried out at much shorter intervals as no ceramic ferrules have to be fitted and removed in each welding process.

\*) Corgon®18 is a gas mixture of Linde AG in D-82049 Höllriegelskreuth

### 3.3 Technical data

Designation	BMK-12i
Welding process	Drawn arc stud welding (DS)
Welding range	SOYER® threaded studs, DIN EN ISO 13918 from M3 – M10 RD (MR) or Ø 2 – 10 mm or M6 – M12 HZ-1
Material	Steel, stainless steel and heat-resistant steel (aluminium conditionally depending on respective requirements)
Power source	Inverter technology
Welding current	350 up to 800 A (stud welding)
Welding time	10 up to 300 ms
Welding sequence	Ø 3 mm up to 12 studs/min. / Ø 10 mm up to 3 studs/min.
Standard gun	PH-9 SRM stud welding gun
Power supply	CEE 32 A (3P + safety earth conductor) 3 x 400 V (+10% -15%) - 50/60 Hz – 16/32 AT
E-constant current (stand-by)	< 0.1 A / phase
E-constant power (stand-by)	15 VA
E-peak current	60 A / phase with 3 x 400 V (short-time operation)
Open-circuit power	< 30 V / DC (direct voltage)
System of protection	IP 41
Shielding gas supply	max. 12 l/min.
Dimensions	95 x 210 x 320 (w x h x d)
Weight with connecting lead	7.5 kg
Colour	Blue anodized
Technical specifications are subject to change without notice	

	<p><b>WARNING</b></p> <p>The "S" symbol is the symbol for welding current sources permitted for operation with increased electrical danger. The "S" symbol on our stud welding devices refers exclusively to the welding current circuit and not to the complete stud welding equipment.</p>
---	--



## 4 Start-up

### 4.1 Installation of equipment

The top of the BMK-12i stud welding inverter is equipped with a carrying handle.

	<p><b>CAUTION</b></p> <p>The carrying handle is intended for transport by hand only. Never pull ropes through this handle to lift the welding equipment by means of a crane to the installation site. The welding equipment would become instable and might tilt from its original position. As a result the handle could rip and the equipment would fall on the ground.</p>
---	---

- Only install the welding equipment on an even surface. The plastic feet located on the bottom of the equipment guarantee its anti-skid position.
- Although the welding equipment is resistant to environmental influences, it should be protected against dampness and dust.
- Please pay particular attention to the bearing strength of the workshop furniture and ensure a safe and stable position of the welding equipment.
- Make sure there is sufficient free space around the air apertures, otherwise the excess temperature safety mechanism will respond and interrupt the welding process.
- Install the stud welding equipment close to the welding location.
- Ensure correct connected loads for electrical connections:  
Socket CEE 32A – 6h; 3 x 400 V~ / 50 Hz / 60Hz.

**The BMK-12i stud welding inverter has a four-core connecting cable: 3P + safety earth conductor.**

- Please observe that additional extension cables cause a voltage drop, possibly leading to system disturbances.
- When welding with shielding gas, make sure the gas cylinder is installed safely in its approved, accident-proof installation device.

	<p><b>NOTE</b></p> <p>The housing of BMK-12i stud welding inverter corresponds to safety class IP 41. Please observe that this system of protection is not suitable for being operated or transported in the rain.</p>
---	--

## 4.2 Front and rear view

### Front view of BMK-12i



### Rear view of BMK-12i

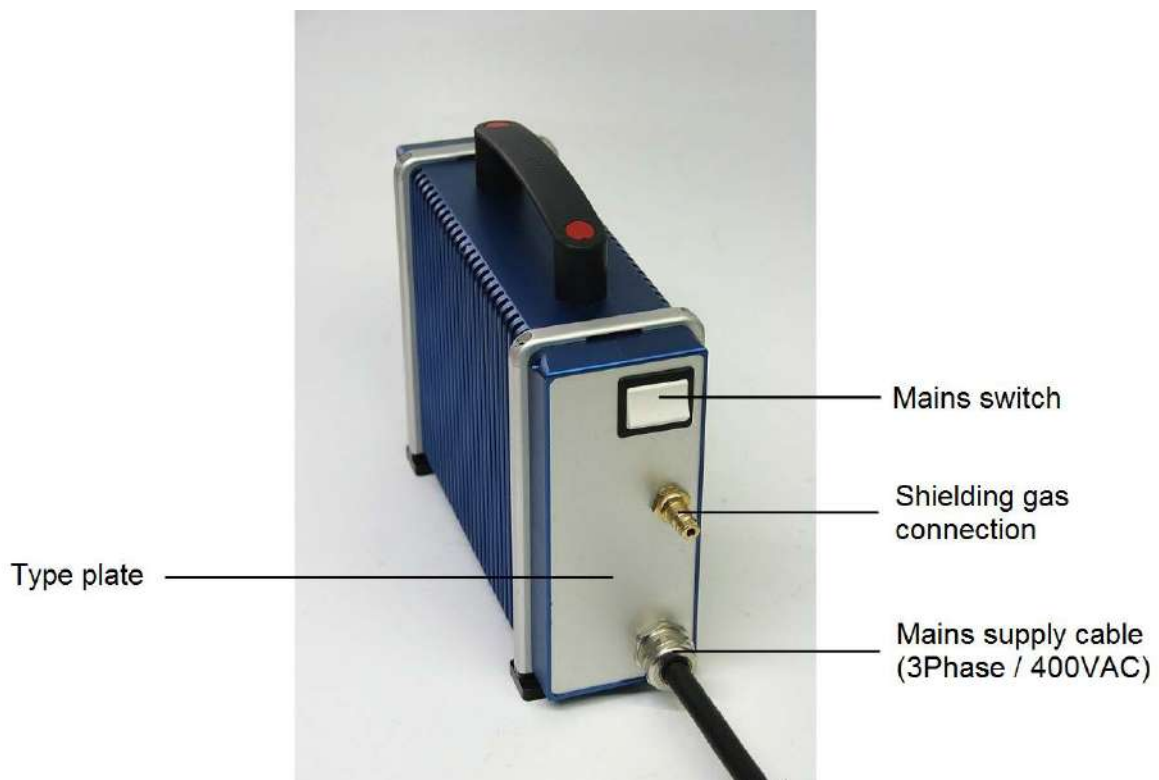

#### 4.2.1 Operating elements

- **ON/OFF switch**

The equipment is activated by moving the rocker switch on the rear of the equipment into the "I" position. The operating status is indicated on the activated display.

The equipment is deactivated by moving the rocker switch on the rear of the equipment into the "O" position. The equipment is then immediately disconnected from the mains supply. The display, however, deactivates after approx. 5 seconds.

#### Function keys for setting the welding parameters

The equipment comprises 4 function keys on the front panel, which are used for navigating through the menu and setting the desired parameters. The current function of the 4 keys is shown in the display. The functions are as follows (from left to right):



- 4.1 - "Navigate upwards" function key
- 4.2 - "Navigate downwards" function key
- 4.3 - "Navigate to right or parameter plus" key
- 4.4 - "Navigate to left or parameter minus" key

Only the functions enabled in the selected menu item are displayed.

#### 4.2.2 Description of the display unit

The menu is divided into three pages called Main parameters, Additional parameters and System settings. To navigate between the three menu pages, set the selection bar on the first line of Main parameters, Additional parameters or System settings. To navigate between the three pages, use the function keys. To change a parameter on one of the three pages, select it first by means of the "Navigate downwards" function key. Then, using the parameter plus/minus function keys, the desired value can be set. As soon as the lower or upper parameter threshold has been reached, the corresponding symbol of the related function key + or - disappears and thus indicates that the parameter threshold has been reached.



### 4.2.3 Description of the operating modes and parameters

#### Operating modes

Several operating modes are available which have been allocated to specific parameter lines. The "Operation" operating mode, which is set for regular welding work, is available on the Main Parameters page, in the Program, Main current (A) and Main current time (ms) lines. When selecting the "Gas pre-flow time (ms)" parameter, on the other hand, the operating mode changes over to "Gas test".

Mode	Description
Operation	Mode for regular welding operation.
SRM test	Mode for testing the magnetic field without igniting an arc.
Pre-weld current	Mode for testing the pre-weld current without connecting the main current.
Lift test	Measurement of the gun fall time for the indirect measurement of the lift height without igniting an arc.
Gas test	Gas test

In the following tables, the three pages with their respective modes for each line are indicated:

#### Main parameter

Menu item	Description	Area / increment	Mode
Main parameters	Page navigation with the keys 6.1 and 6.2		Stand-by
Program	Program selection (1 to 10)	1 to 10 / 1	Operation
Main current [A]	Main current value in ampere	350 to 800 / 10	Operation
Main current time [ms]	Time of the main current in milliseconds	10 to 300 / < 50 = 1 / > 50 = 5	Operation
SRM current [mA]	Direct current value of the SRM coil in milliamperere	0 to 1500 / 50	SRM test
Gas pre-flow time [ms]	Time of the gas flow in milliseconds before the start of the welding process	0 to 5000 / 500	Gas test
Drop time [ms]	Measurement of the gun drop time for the indirect measurement of the lift height.	Resolution in 0.25 milliseconds	Gun drop test

#### Additional parameters

Menu item	Description		Mode
Additional parameters	Page navigation with the keys 6.1 and 6.2		Stand-by
Program	Program selection (1 to 10)	1 to 10 / 1	Operation
Pre-weld current time [ms]	Pre-weld current time in milliseconds	20 to 50 / 10	Pre-weld current test
Pre-weld current [A]	Pre-weld current value in ampere	50 to 80 / 10	Pre-weld current test
Gas post flow time [ms]	Time of the gas flow in milliseconds after completion of the welding process	0 to 5000 / 100	Gas test

## System settings

Menu item	Description		Mode
System settings	Page navigation with the keys 6.1 and 6.2		Stand-by
Background illumination	Setting of the display background illumination	50 up to 100 %	Stand-by
Software version	Version number of the software		Stand-by

**Please note:**

The program positions 1 - 10 can be freely assigned by the user. Depending on the welding task, the welding parameters can be determined and assigned to the positions 1- 10 as user program. The modified parameters are saved by pressing the release button on the gun or by completing a weld.



#### 4.2.4 Overview of menu items

**MAIN PARAMETERS**

Program	1
Main current [A]	800
Main current time [ms]	150
SRM current [mA]	500
Gas pre-flow time [ms]	1500
Drop time [ms]	10

**MAIN PARAMETERS**

Program	1
Main current [A]	800
Main current time [ms]	150
SRM current [mA]	500
Gas pre-flow time [ms]	1500
Drop time [ms]	10

**OPERATION**

▲ ▼ +

**MAIN PARAMETERS**

Program	1
Main current [A]	800
Main current time [ms]	150
SRM current [mA]	500
Gas pre-flow time [ms]	1500
Drop time [ms]	10

**OPERATION**

▲ ▼ -

**MAIN PARAMETERS**

Program	1
Main current [A]	800
Main current time [ms]	150
SRM current [mA]	500
Gas pre-flow time [ms]	1500
Drop time [ms]	10

**OPERATION**

▲ ▼ + -

**MAIN PARAMETERS**

Program	1
Main current [A]	800
Main current time [ms]	150
SRM current [mA]	500
Gas pre-flow time [ms]	1500
Drop time [ms]	10

**OPERATION**

▲ ▼ + -

**MAIN PARAMETERS**

Program	1
Main current [A]	800
Main current time [ms]	150
SRM current [mA]	500
Gas pre-flow time [ms]	1500
Drop time [ms]	10

**GAS TEST**

▲ ▼ + -

**MAIN PARAMETERS**

Program	1
Main current [A]	800
Main current time [ms]	150
SRM current [mA]	500
Gas pre-flow time [ms]	1500
Drop time [ms]	10

**LIFT-TEST**

▲

**ADDITIONAL PARAMETERS**

Program	1
Pre-weld current time [ms]	20
Pre-weld current [A]	80
Gas post flow time [ms]	1500

**ADDITIONAL PARAMETERS**

Program	1
Pre-weld current time [ms]	20
Pre-weld current [A]	80
Gas post flow time [ms]	1500

**OPERATION**

▲ ▼ +

**ADDITIONAL PARAMETERS**

Program	1
Pre-weld current time [ms]	20
Pre-weld current [A]	80
Gas post flow time [ms]	1500

**PRE-WELD CURRENT TEST**

▲ ▼ +

**ADDITIONAL PARAMETERS**

Program	1
Pre-weld current time [ms]	20
Pre-weld current [A]	80
Gas post flow time [ms]	1500

**PRE-WELD CURRENT TEST**

▲ ▼ -

**ADDITIONAL PARAMETERS**

Program	1
Pre-weld current time [ms]	20
Pre-weld current [A]	80
Gas post flow time [ms]	1500

**GAS TEST**

▲ + -

**SYSTEM SETTINGS**

Backgrnd. illumination [%]	100
----------------------------	-----











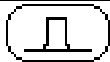

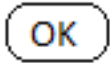
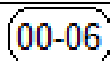
**SYSTEM SETTINGS**

Backgrnd. illumination [%]	100
----------------------------	-----

**SYSTEM SETTINGS**

Backgrnd. illumination [%]	100
----------------------------	-----

#### 4.2.5 Description of symbols

Symbol	Description	Function
	"Release"	Symbol lights up when pressing release button of welding gun.
	"Stud on Workpiece"	Symbol lights up when earth terminal is connected and stud touches the workpiece.
	"Gas active"	Symbol lights up when shielding gas valve is open.
	"SRM active"	Symbol lights up when SRM magnetic field is active.
	"No fault"	There is no fault of welding equipment and all temperatures are within an uncritical range.
	"Fault error code"	A fault is at hand. See chapter 5.7.
	Function key 6.1 - "Arrow up"	Upward modification of the operating mode and the selected parameters (shown flashing in the display).
	Function key - 6.2 "Arrow down"	Downward modification of the operating mode and the selected parameters (shown flashing in the display).
	Function key 6.3 - "Arrow left"	Move one menu page to the left.
	Function key 6.4 - "Arrow right"	Move one menu page to the right.
	Function key 6.3 - "Parameter plus"	Increase parameter by one increment.
	Function key 6.4 - "Parameter minus"	Reduce parameter by one increment.
	Gas connection	Identification of the gas connection for the welding gun, Coupling socket KD - 1/4.
	Ground	Identification of the ground cable plug for connecting the ground cable.
	Gun	Identification of the control cable and welding cable sockets for connecting the gun.

### 4.3 Preparation for start-up

Connect the stud welding gun and earth cable to the welding equipment prior to start-up.

#### 4.3.1 Earth connection

- Attach earth cable to earth cable connector marked with the EARTH/GROUND symbol and lock by turning to the right until stop.
- Attach earth clamps to workpiece.

	<p>Ensure optimum contact with workpiece. Owing to the high welding current, an unbalanced current distribution may cause a magnet blow effect on the arc, i.e. the arc for welding the stud is asymmetrical. This is shown by an irregular course of the weld upset on the side of the stud. The welding results are unsatisfactory and not reproducible.</p>
---	--

For this reason, you should attach the earth clamps to the workpiece so that the welding gun is positioned as close as possible to the centre of the connecting route of both earth clamps. This guarantees a current distribution around the stud that is optimally balanced and also good welding results.

Difficult areas are welds on the edge of the workpiece or where there are greater inhomogeneities in material thickness, i.e. the material thickness varies by a few millimetres or additional material is welded or riveted to the metal. This also includes stud welding on profile sections.

To ensure good welding results, carry out several test welds under different conditions. For example, simply change the position of the earth clamps or turn the welding gun.

You may determine the symmetry and quality of the arc during the pre-weld current test and then optimise them by means of adequate combinations of the earth connection and the gun position.

	<p>Please ensure that the contact areas of the earth clamps are always kept clean and do not oxidize, otherwise high transition resistances could occur that may result in a considerable reduction of the rated welding current.</p>
---	---

In addition, make sure that the earth clamps are clamped securely to the workpiece and the earth cables as well as the gun cable are securely connected to the welding equipment. This prevents high transition resistance and arc losses on the clamps or plug-in connections which in turn would lead to poor welding results.

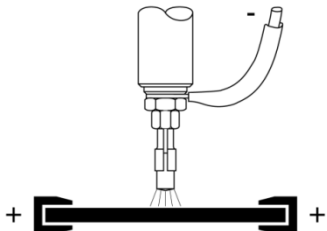
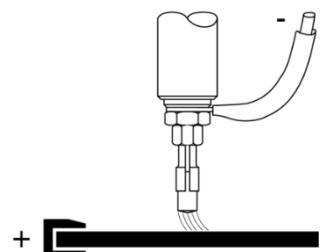
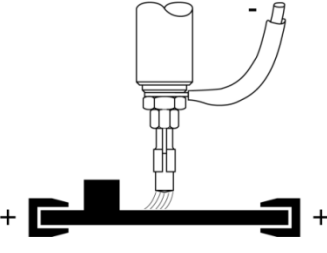

Examples for various earth connections and possible effects:

<p>Balanced earth connection</p> <p>Ideal condition: The stud is located in the centre of both earth connections.</p>	
<p>Unbalanced earth connection</p> <p>Arc is deflected to the side where there is less current density.</p>	
<p>Additional masses disturb arc symmetry.</p>	

#### 4.3.2 Connection of stud welding gun

- Connect welding cable of welding gun to the relevant socket and lock it by turning to the right until stop.
- Insert control cable into control cable connection and tighten with sleeve nut.
- Please follow the connecting instructions given in the operating manual for the welding guns.

#### 4.4 Preparation of gas supply

Gas supply must be provided before welding with shielding gas.

The gas connection at the rear side of the welding equipment serves to supply the welding equipment with gas via a pressure regulator (pressure reducing valve not included in delivery). The maximum admissible gas flow rate is 12 l/min.

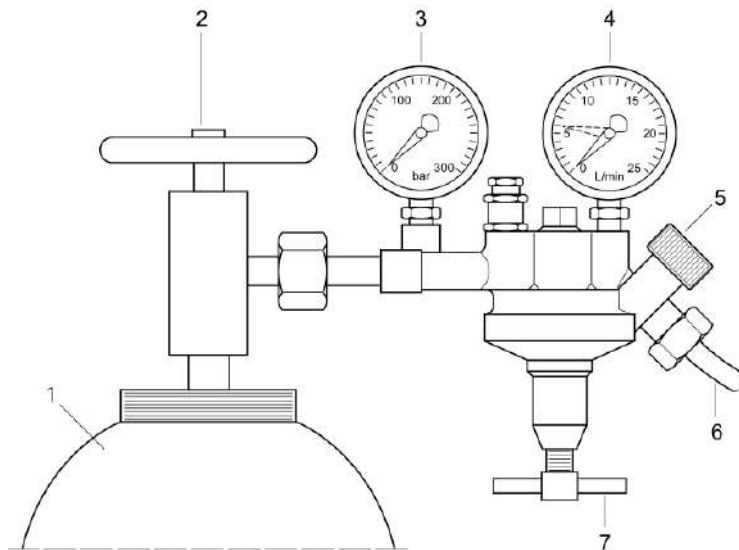



KZ.0016.X

Example for gas supply. Deviations are possible depending on the manufacturer

1 Gas cylinder	5 Shut-off valve
2 Hand wheel (left = open, right = closed)	6 Gas supply hose
3 Manometer for indicating the gas cylinder's pressure	7 Control cock for gas flow rate - Screwing in increases the flow - Screwing out decreases the flow
4 Flow meter	

- Connect gas supply hose and gas hose of pressure reducing valve (pressure reducing valve not included in delivery) to the welding equipment.
- Open hand wheel (item 2) of gas cylinder.
- Open shut-off valve (item 5).
- Use control cock (item 7) to set shielding gas flow rate to a maximum of 4 - 5 l/min.

	<p><b>NOTE</b> Make sure the gas cylinder is installed safely in an approved, accident-proof installation device.</p>
---	---

	<p><b>NOTE</b> As protective gas, we recommend using the following gas mixtures: 90% Argon and 10% CO<sub>2</sub> <b>82% Argon and 18% CO<sub>2</sub></b> 85% Argon and 15% CO<sub>2</sub></p>
---	--

#### 4.4.1 Gas supply

When welding with shielding gas, provide the following connections:

- Insert coupler plug of the welding gun's gas supply hose into the gas supply socket of the welding equipment.
- Connect the gas hose of the pressure reducing valve (pressure reducing valve not included in delivery) to the shielding gas connector at the rear side of the welding equipment.

#### 4.4.2 Power supply

Use the mains cable to connect the welding equipment to the power supply.

	<p><b>MORTAL DANGER</b> Ensure correct connected loads for electrical connections as indicated on the type plate of the welding equipment.</p>
---	--

#### 4.5 Starting the welding equipment



After switching on the welding equipment, an animation appears and the welding equipment carries out a self-test which runs in the background.

The welding equipment is locked during the self-test and cannot be operated. After the self-test has been successfully carried out, the welding equipment automatically sets the parameters, menu page and menu line which were last set.

#### 4.6 Test modes

##### 4.6.1 Operating mode "Pre-Weld Current Test"

The operating mode "Pre-weld current test" enables a function test using the set parameters without application of main current and serves to control the gun setting.

	
<p><b>ADDITIONAL PARAMETERS</b></p>	<p><b>ADDITIONAL PARAMETERS</b></p>
<p>Program 1</p>	<p>Program 1</p>
<p>Pre-weld current time [ms] 20</p>	<p>Pre-weld current time [ms] 20</p>
<p>Pre-weld current [A] 80</p>	<p>Pre-weld current [A] 80</p>
<p>Gas post flow time [ms] 1500</p>	<p>Gas post flow time [ms] 1500</p>
<p><b>PRE-WELD CURRENT TEST</b></p>	<p><b>PRE-WELD CURRENT TEST</b></p>
<p>▲ ▼ +</p>	<p>▲ ▼ -</p>

	<p><b>CAUTION</b> Protective goggles are required to carry out this test. Please also refer to the safety instructions in chapter 1.</p>
---	--

#### 4.6.2 Operating mode "Lift Test"

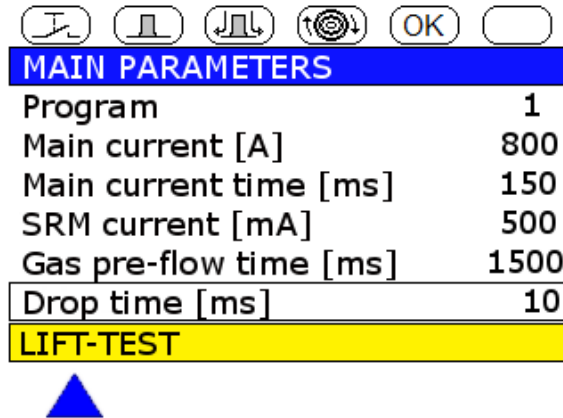

This operation mode enables you to adjust and check the lift of the gun.

- Select the operating mode "Lift Test".
- Insert a stud into the welding gun.
- Check the immersion depth of the stud and set it according to the operating instructions of the welding gun.

	<p><b>CAUTION</b> Ensure once again that the operation mode is set to "LIFT" and comply with the safety instructions in chapter 1.</p>
---	--

- Position gun on workpiece. The LED "Stud on workpiece" lights up.
- Press the release button of the gun.

If necessary, check and correct the height of lift according to the specified standard values.

If the lift test is carried out on a workpiece which is connected to the earth connection of the welding equipment, the drop time will be shown on the display in milliseconds (ms).

	<p><b>NOTE</b> Do not activate the release too often at short intervals. This can cause the thermo safety mechanism protecting the lifting magnet to react and the current supply for the magnet will be interrupted. This condition is shown as error message on the display.</p>
---	--

### 4.6.3 Operating mode "Gas Test"

MAIN PARAMETERS	
Program	1
Main current [A]	800
Main current time [ms]	150
SRM current [mA]	500
Gas pre-flow time [ms]	1500
Drop time [ms]	10
GAS TEST	

ADDITIONAL PARAMETERS	
Program	1
Pre-weld current time [ms]	20
Pre-weld current [A]	80
Gas post flow time [ms]	1500
GAS TEST	

This operating mode checks whether the shielding gas is flowing through the gas shroud of the welding gun. As soon as the triggering button of the gun is pressed, shielding gas flows out of the gas shroud on the welding gun for approx. 3 seconds. This enables you to rinse the gas supply lines with shielding gas before starting to weld.

- Select the operating mode "Gas pre-flow time" or "Gas post flow time" in the menu to get to the operating mode "Gas Test".
- Connect gas supply (pls. refer to chapter "GAS SUPPLY")
- The gas valve may be activated by the triggering button of the welding gun.









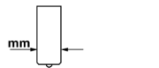

## 4.7 Welding parameters

	<p><b>NOTE</b></p> <p>The set welding parameters substantially influence the reproducibility and quality of the welding results. The parameters depend on the size of the studs and the material properties. The values indicated in the tables are standard values which are exclusively valid for studs supplied by SOYER®. They may vary depending on the type of workpiece, the workpiece thickness, the surface condition of the workpiece and on environmental conditions (e.g. low outdoor temperatures). The settings of the welding gun or welding head also influence the welding parameters.</p>
---	---

Random samples should be taken during any production process to ensure consistently good welding results (see DVS guideline, Part 1, "Quality assurance of stud welding joints").

The welding parameters were determined with the BMK-12i welding equipment and the PH-9 SRM stud welding gun using a lift adjustment of about 2.0 mm. A steel plate with a thickness of 5 mm served as base metal for SOYER® weld studs as per DIN EN ISO 13918.

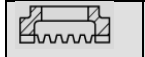
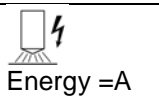
**Table for welding parameters**

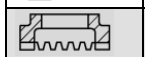
		For weld studs as per DIN EN ISO 13 918									
		6		8		10		12		14	
		~2.5	~3	~2.7	~3.5	~2.8	~4	~3	~4.2	~3.2	~4.5
		~1.5	~1	~1.6	~1.2	~2	~1.3	~2.3	~1.5	~2.6	~1.8
 Time =ms		~ 120		~ 200		~ 250		~ 350		--	
		~ 200		~ 250		~ 350		~ 500		~ 600	
 Energy =A		~ 450		~ 550		~ 800		~ 1000		--	
		~ 350		~ 500		~ 700		~ 900		~ 1000	

**Please note:**

The program positions 1 - 10 can be freely assigned by the user. Depending on the welding task, the welding parameters can be determined and assigned to the positions 1- 10 as user program.

## 5 Operation

### 5.1 Brief description

This section is designed to provide you with a quick start into the welding operation. For detailed information, please refer to **chapter 5.2**.

	<p><b>NOTE</b> The relevant accident prevention and safety regulations must be complied with when operating the welding equipment.</p>
---	--

	<p><b>NOTE</b> The welding areas must be metallically bright. → If necessary, grind the area to be welded.</p>
---	--

- Switch on mains switch.

	<p>After switching the welding equipment on, all eight LED lamps light up for a short period.  Depending on the respective operating state, further messages are shown via the digital display.</p>
---	---

- Set operating mode "Lift test" and check the welding gun's height of lift.

	<p><b>NOTE</b> The height of lift is the distance for which the stud is lifted from the workpiece during the welding process. This distance is required for igniting the arc. <b>The height of lift should amount to approx. 1.5 mm.</b></p>
---	--

- Set welding equipment to the "Operation" mode.
- Choose welding parameter depending on stud diameter using the function keys.
- Position welding gun with weld stud on the workpiece. When earth connection is made and the stud in the gun touches the workpiece, the LED "Stud on Workpiece" (SOW) lights up.

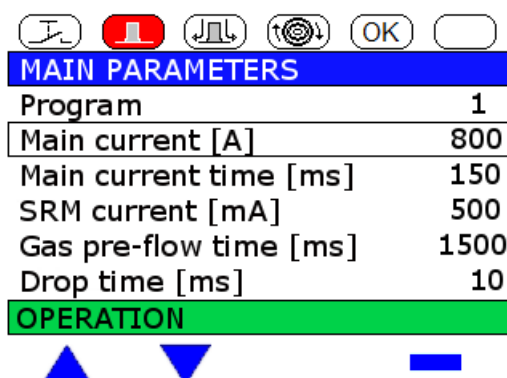



- Press the push button. The LED "Release" lights up and the stud welding process is started. The active functions are displayed by the LEDs: Start button / Inert gas / SRM.



MAIN PARAMETERS	
Program	1
Main current [A]	800
Main current time [ms]	150
SRM current [mA]	500
Gas pre-flow time [ms]	1500
Drop time [ms]	10

OPERATION







During the welding process, keep the gun steady. After completion of the welding process, remove gun vertically from the welded stud to prevent widening and damaging of the stud chuck. In case of automatic operation, a weld stud will be reloaded.



## 5.2 Basic setting of the SRM stud chuck

SRM stud chucks are available in the following different sizes: M8, Ø 9 mm, M10, Ø 10.8 mm, M12 and M14.

	<p>The SRM stud chuck has been specifically designed for the PH-3N and PH-9 stud welding guns. For different stud diameters, different stud chucks are required.</p>
	<p>Insert weld stud into stud chuck.</p>
	<p>The weld stud must make contact with the stop screw. Adjust stop screw in the stud chuck by turning it until the distance between the top edge of the stud flange and the front edge of the stud chuck equals 3 – 5 mm.</p>
	<p>Ensure depth of immersion / stud protrusion is set between 3 mm and 5 mm. After adjustment, check and correct if necessary. Hand-tighten by means of the fixing nut.</p> <p><b>With a stud protrusion of more than 5 mm, the necessary transverse magnetic field is deflected laterally which may lead to an uncontrolled SRM welding.</b></p>

### 5.3 Basic setting of the SRM nut holder

The SRM nut holder is available for M6, M8, M10 and M12 nuts.

	<p>The SRM nut holder has been specifically designed for the PH-3N and PH-9 stud welding guns. The SRM nut holder can be installed directly.</p>
	<p>Insert nut into nut holder.</p> <p>The nut holder is already factory-set to our weld nuts.</p> <p>No further adjustment is required.</p>
	<p>1 Centring insert 2 Weld nut 3 Nut holder</p>

#### *Possible material combinations for nut welding with SRM*



Weld nut of A2-50 /stainless steel	Sheet metal of stainless steel	well suited
Weld nut of A2-50 /stainless steel	Sheet metal of steel	well suited
Weld nut of steel	Sheet metal of steel	not suited

A galvanised sheet metal is generally not recommendable. You can, however, remove the zinc layer from the workpiece according to the diameter of the weld nut by means of cutting or mechanical processing.

#### *Note for nut welding on non-punched sheet metal*

Use our weld nuts without centring inserts for non-punched sheet metal. The PH-3N stud welding gun with welding nut is positioned on the workpiece without further aids. The positioning is completed “manually”, using a template or suitable fixture.

Note for nut welding on punched sheet metal

	<p>Use our weld nuts with centring inserts for punched sheet metal. Thanks to our centring insert, the weld nut is welded centrally over a hole.</p> <p><b>TIP</b> When using a template or other equipment, it is not necessary to use the centring insert. Without the centring insert, spatters might, however, stick in the thread.</p>						
	<p>Weld nut with centring insert.</p> <p><b>Important!</b> The hole diameter must be prepared according to the nut size.</p>						
<p>For an optimal welding result, you must comply with the following hole diameters:</p> <table data-bbox="196 1182 1332 1279"> <tr> <td>M8 weld nut with centring insert</td> <td>Ø 9.5 mm (punched holes, preferably burr-free)</td> </tr> <tr> <td>M10 weld nut with centring insert</td> <td>Ø 12 mm (punched holes, preferably burr-free)</td> </tr> <tr> <td>M12 weld nut with centring insert</td> <td>Ø 14 mm (punched holes, preferably burr-free)</td> </tr> </table>		M8 weld nut with centring insert	Ø 9.5 mm (punched holes, preferably burr-free)	M10 weld nut with centring insert	Ø 12 mm (punched holes, preferably burr-free)	M12 weld nut with centring insert	Ø 14 mm (punched holes, preferably burr-free)
M8 weld nut with centring insert	Ø 9.5 mm (punched holes, preferably burr-free)						
M10 weld nut with centring insert	Ø 12 mm (punched holes, preferably burr-free)						
M12 weld nut with centring insert	Ø 14 mm (punched holes, preferably burr-free)						

#### 5.4 Start-up of the PH-9 SRM stud welding gun

**NOTE:**







The PH-3N SRM welding gun is only suitable for stud sizes M6 - M12 and weld nut sizes M8, M10 and M12!

**TIP:**

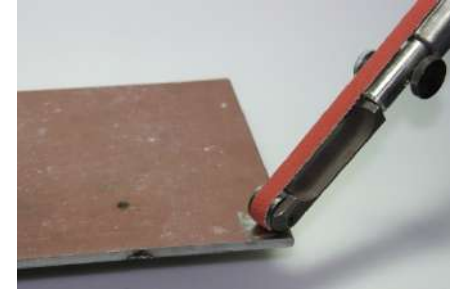
The PH-3N SRM welding gun is provided with a standard gas shroud. Use inert gas to avoid the formation of pores and to optimise the collar formation.

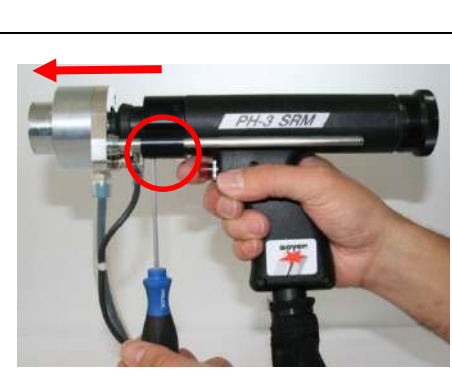
**With this example we explain the necessary work steps in detail. This example applies accordingly to other stud welding guns.**

 <p>SRM nut holder</p>	 <p>SRM stud chuck</p>
	<p>Connection of welding equipment:</p> <ol style="list-style-type: none"><li>1. Connect welding cable of welding gun and lock by turning to the right.</li><li>2. Connect gas hose.</li><li>3. Insert control cable of welding gun into control cable connection and lock by turning to the right.</li><li>4. Connect ground cable and lock by turning to the right.</li><li>5. Provide gas supply.</li></ol>



	<p><b>If necessary</b>, prepare the ground connection (use protective goggles).</p> <p>The contact areas for the ground connection must be metallically bright.</p> <p><b>TIP:</b> You can improve the transition resistances if both sides of the locking pliers have contact with the ground.</p> 
	<p><b>NOTE:</b></p> <p>To facilitate the installation of the stud chuck or nut holder, move or dismantle the support together with the gas shroud.</p> <p>To do so, loosen the four Allen screws.</p>
	<p>The welding equipment must be <u>switched off</u> when installing the stud chuck or nut holder.</p>  <p>Loosen sleeve nut with a SW 17 socket wrench or SW 17 open-end wrench.</p> <p>Insert the chuck into the spring piston and push it firmly until it comes to a stop.</p>
<p>Support not illustrated</p>  <p>Support not illustrated</p>	<p>Hand-tighten sleeve nut with a SW 17 socket wrench or SW 17 open-end wrench.</p>



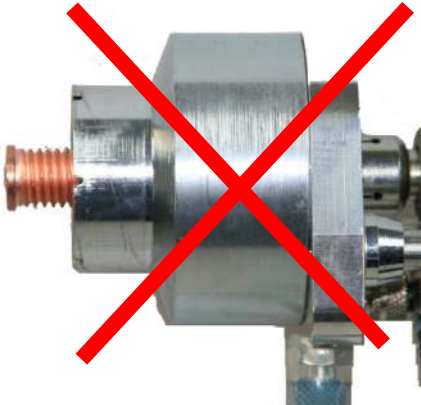
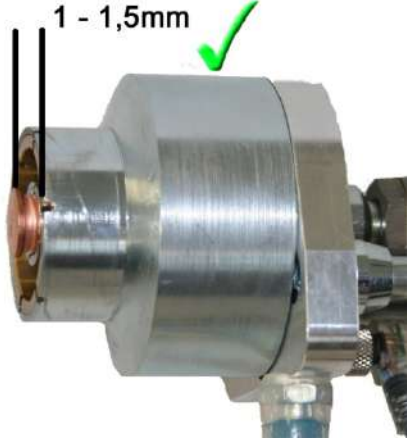

	<p><b>How to correct the stud protrusion</b></p> <p>Insert the weld stud / weld nut into the chuck / nut holder and push it firmly until it comes to a stop. Use Allen wrench (size 3) to loosen the four Allen screws. Move support until a stud protrusion of approx. 1 – 1.5 mm is obtained.</p> <p>Tighten Allen screws.</p>
---	--

**Ensure stud protrusion is set between 1 mm – 1.5 mm**

**The stud must protrude for about 1 mm– 1.5 mm from the SRM gas shroud!**

	
--	---

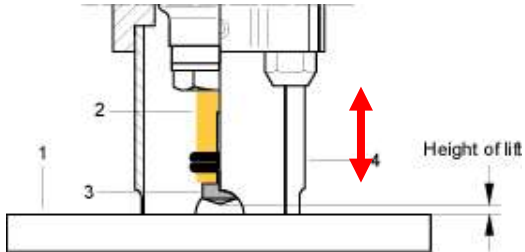
	<p>Connect power cable.</p> <p><b>Ensure correct connected loads for electrical connections (see type plate on stud welding equipment).</b></p> <p><b>Standard design</b> CEE 32 A (3P + protective earth conductor) 3 x 400 V 50/60 Hz</p> <p>Important: Slow-blow fuse, no automatic circuit breakers.</p> 
---	--

	<p>Switch stud welding equipment on with the mains switch.</p> <p>Please observe the safety instructions!</p> <div style="display: flex; justify-content: space-around; align-items: center;">   </div>
	<p><b><u>Adjusting and checking the height of lift</u></b></p> <p>The height of lift is the distance by which the stud is lifted from the workpiece during the welding process. This distance is required for igniting the arc.  <b>The height of lift should amount to approx. 1 – 1.5 mm.</b></p> <p><b>Tip:</b>      With the SRM stud welding method, you often achieve better results with a smaller lifting height.</p>
	<p><b>To adjust and check the height of lift, please select the operating mode "Lift Test".</b></p> <ul style="list-style-type: none"> <li>• Position welding gun on the workpiece.</li> <li>• Press the trigger. The gun lifts the chuck with weld stud away from the workpiece.</li> </ul> <p>Adjustment of the gun lift is achieved by turning the rear adjustment cap of the welding gun to the left or to the right.</p> <p>Anti-clockwise rotation increases the gun lift and conversely clockwise rotation reduces the gun lift.</p>
	<ul style="list-style-type: none"> <li>• Please ensure that the welding parameters are set in accordance with the respective stud diameter.</li> <li>• Please make sure gas supply has been properly connected.</li> <li>• Check and adjust accordingly if necessary.</li> </ul>





Position welding gun vertically on the workpiece (at a 90-degree angle to the workpiece).  
Check the selected parameters. Start the welding process by pressing the trigger.

During the welding process, keep the gun steady. After completion of the welding process, remove gun vertically from the welded stud to prevent widening and damaging of the stud chuck.

Please carefully observe all safety instructions!





## 5.5 Notes on the "Lifting test" operation mode

The lifting test allows for the activation of the gun's lifting magnet thus controlling the setting.

Proceed as follows:

- Provide ground connection to the workpiece, connect welding gun.
- Mount stud chuck on the welding gun and insert weld stud into stud chuck.
- Select operation mode "Lift test".

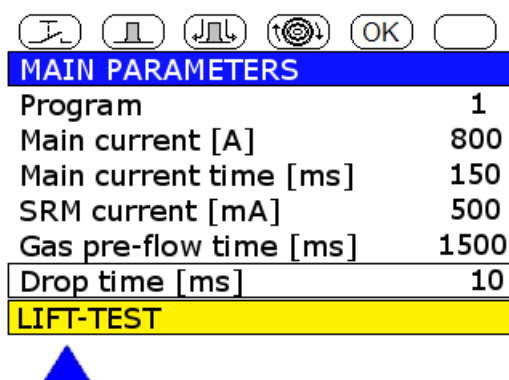

- Press the trigger. A lifting cycle is carried out using the control parameters of a real weld.

	<p><b>NOTE</b></p> <p>The appropriate lifting height can be adjusted by rotating the adjusting cap at the rear side of the welding gun to the left or to the right.</p> <p><b>The lifting height should be approximately 1.5 mm.</b></p>
---	--

This procedure can be repeated as frequently as required. To avoid overheating the magnetic coil, a waiting time of approx. one second must be observed between two test lifts.

If at the beginning of the lifting cycle **BAW** (**SOW** = stud positioned on workpiece) is recognised, the welding equipment will display the drop time of the gun in ms (milliseconds) with a resolution of 0.25 ms.

This time measurement starts with the deactivation of the lifting magnet and stops as soon as the stud touches the workpiece.

## 5.6 SRM welding operation

Using this patented welding process (patent no.: 10 2004 051 389), threaded studs, pins, tapped studs etc. can be welded to metallic workpieces of alloyed and unalloyed steel.

You need a stud welding gun equipped with a special fixture for SRM stud welding.

Due to the inert gas shroud with integrated magnetic coil, a magnetic field is generated. Depending on the welding task, the current in mA for the power of the magnetic field can be changed via the SRM parameter.

The setting procedure for further welding parameters such as stud protrusion and lift is similar to that of stud welding without SRM.

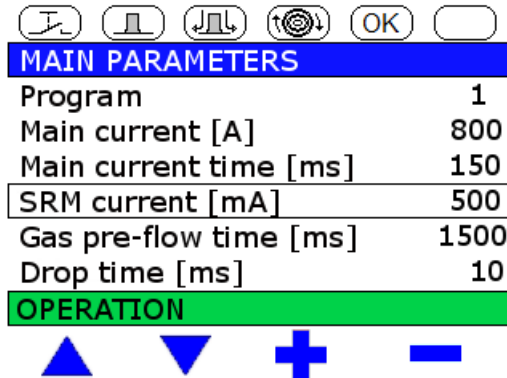

The current intensity (mA) of the radial-magnetic field is altered via the SRM parameters.

SRM = 0 indicates that SRM is not active  
 SRM = 500 current for magnetic field 500 mA

**Range: 0 – 1500 mA adjustable in 50 mA increments.**

### 5.6.1 Stud welding with shielding gas

- Set the parameters required for your welding task.

- 1 Foot plate
- 2 Gas shroud
- 3 Welding stud

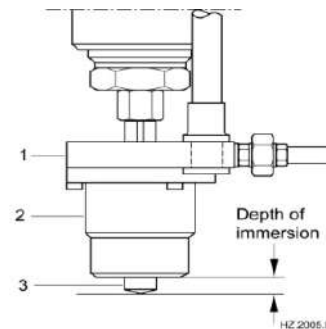

*Fig. Stud welding with shielding gas*

- Set gas flow rate to a value of between 4 and 5 l/min. If the value is too high, the arc is extinguished, if the value is too low, the protective function of the gas is reduced. Welding results are poor in both cases.
- Insert a stud into the welding gun.

	<p><b>DANGER</b>          Never touch stud or stud chuck during the welding process. These components are current-carrying.</p>
---	---

- Position welding gun vertically on the workpiece when welding.

- Press trigger switch.
- When welding with shielding gas, the welding point is rinsed during the welding process as well as before and after welding for the period adjusted.
- The LED "Gas valve open" indicates that the gas valve is open.

## 5.7 Error messages and notes

### 5.7.1 Gun connection

If the gun is not connected or if there is a cable break in the magnetic line of the gun, this is indicated by an error message.

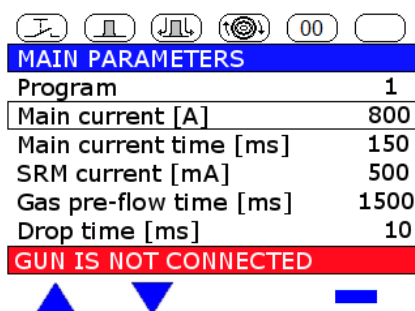

MAIN PARAMETERS	
Program	1
Main current [A]	800
Main current time [ms]	150
SRM current [mA]	500
Gas pre-flow time [ms]	1500
Drop time [ms]	10
GUN IS NOT CONNECTED	

### 5.7.2 Increased temperature

With high welding sequences and high output, the equipment heats up depending on the ambient conditions. A temperature of  $>50^{\circ}\text{C}$  is indicated by the message: "Increased temperature". Welding can be continued. You should however reduce the welding sequence.

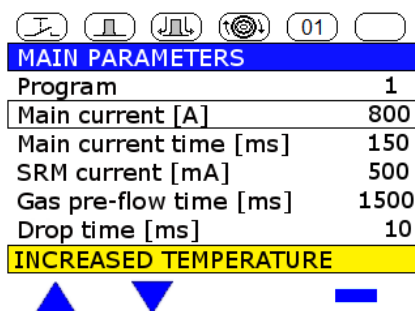

MAIN PARAMETERS	
Program	1
Main current [A]	800
Main current time [ms]	150
SRM current [mA]	500
Gas pre-flow time [ms]	1500
Drop time [ms]	10
INCREASED TEMPERATURE	

### 5.7.3 Excessive temperature

When a temperature of  $55^{\circ}\text{C}$  is reached, the "Excessive temperature" error message appears. Welding is no longer possible. The welding operation is automatically resumed once the equipment has cooled down to below  $52^{\circ}\text{C}$ .

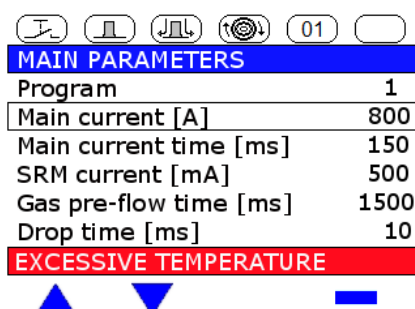

MAIN PARAMETERS	
Program	1
Main current [A]	800
Main current time [ms]	150
SRM current [mA]	500
Gas pre-flow time [ms]	1500
Drop time [ms]	10
EXCESSIVE TEMPERATURE	

### 5.7.4 Phase failure / overvoltage / undervoltage

The equipment continuously monitors the input voltage and responds to a faulty network by displaying the corresponding error message and blocking the welding operation.

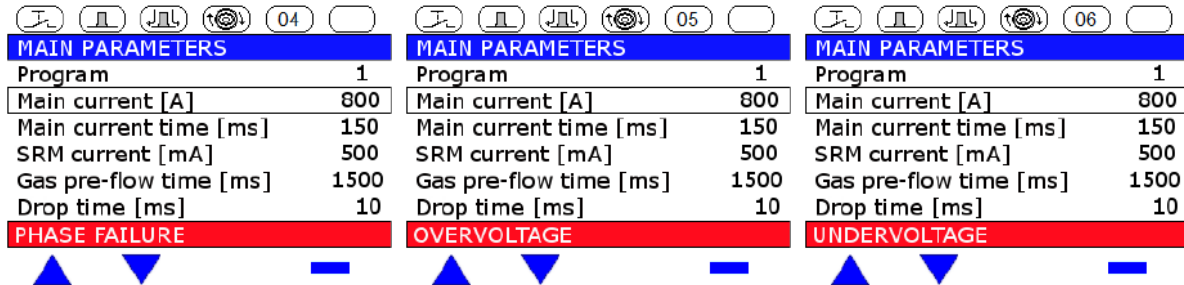

### 5.7.5 Error code table

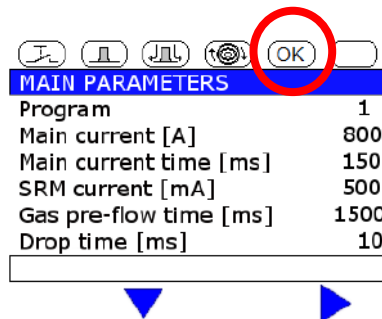

Error code	Error description	Error rectification
00	Gun not connected or cable break of lifting magnet line	Connect the gun or check the lifting magnet line
01	Increased/excessive temperature of inverter	Reduce welding sequence or let equipment cool down
02	Increased/excessive temperature of output rectifier	
03	Increased/excessive temperature of main transformer	
04	Phase failure	Switch off the equipment and check the mains connection
05	Overvoltage	
06	Undervoltage	

## 6 Quality control (stud welding)

### 6.1 General instructions

Provided the SOYER® welding equipment is correctly used and the materials are appropriately selected, the strength of the welding joint (welding zone) will always be stronger than that of the stud or base material.

The following tests are carried out in general practice:

- Visual inspection
- Bend test

Please also refer to the following standards:

**DIN EN ISO 14555** Arc welding of metallic materials  
**DVS 0904** Information on practical application – Arc stud welding

## 6.2 Test execution

### 6.2.1 Production of samples

The dimensions of the test piece must be sufficient to carry out all tests. The thickness of the test piece must be the same as used in later production. Use the same welding positions and edge distances as on the component to be welded later. If possible and sensible from an economical point of view, use parts that are identical to those used in later production.

### 6.2.2 Visual inspection

The visual inspection serves as a rough check for major defects. The uniformity of the weld is assessed.

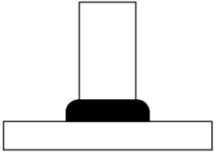
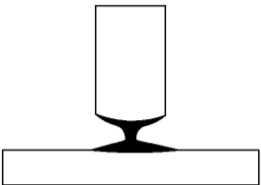
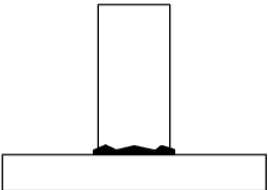
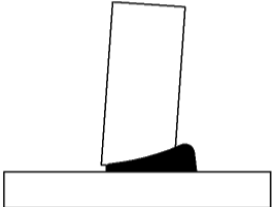
	<p>Good welded joint. Optimum setting. Regular, bright and complete weld upset.</p>
	<p>Poor-quality welded joint e.g. caused by excessive welding energy or insufficient plunge or lift. Stud is constricted at the welded joint. Stud is not completely welded all over the surface.</p>
	<p>Poor-quality welded joint e.g. caused by insufficient welding energy or a lift set too low. Reduced and irregular weld upset.</p>
	<p>Poor-quality welded joint, e.g. caused by arc blow, tilted or unsteady welding position of welding gun. Stud flange is not completely welded and shows visual defects. Weld undercuts are visible.</p>

### 6.2.3 Bend test

The bend test is a simple work test which serves to roughly check the setting values selected. The welding zone is subjected to undefined tension, pressure and bending. A minimum of 3 studs are welded and bent by means of a tube slipped over the stud. The test is successful when no superficial fissure or fracture is detected in the welding zone.

	<p>Bend the studs by 30° when welding with capacitor discharge. With drawn arc welding using shielding gas and with short-cycle drawn arc welding, bend the studs by 60°.</p>
---	---

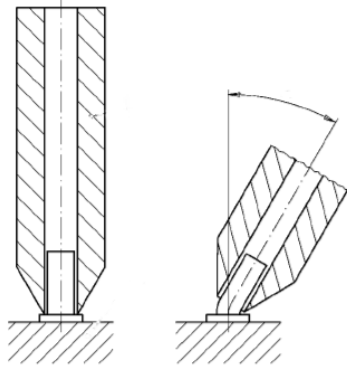

Bend test with tube placed upon the stud

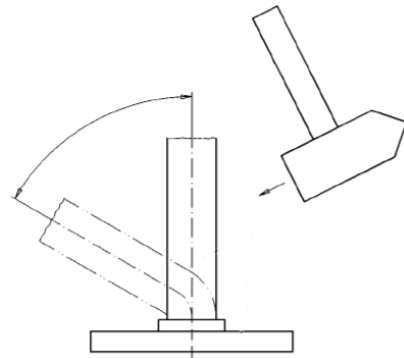

Bend test with hammer

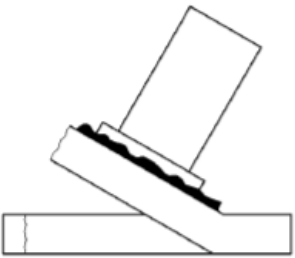
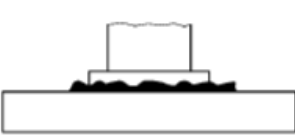
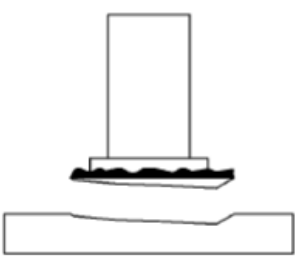
	<p>Good welded joint. Optimum setting. Tearing of parent metal.</p>
	<p>Good welded joint. Optimum setting. Fracture above stud flange.</p>
	<p>Poor-quality welded joint. Fracture in the heat-affected zone.</p>

## 7 Maintenance

### 7.1 Important instructions

The welding equipment is constructed so that only a minimum of maintenance is required. It should, however, be cleaned by a specialist at regular intervals depending on the environmental conditions at the location of use.

	<p><b>WARNING</b></p> <p>Our BMK-12i is a highly integrated, state-of-the-art stud welding equipment. The service personnel are required to meet special qualifications. If the housing of the welding equipment is opened by untrained service personnel, the proper function of the welding equipment can no longer be guaranteed. Our after-sales service has adequately trained personnel, suitable service equipment and the means to carry out all necessary works. In case of technical faults, please contact our service department.</p>
---	---

### 7.2 Important instructions for all service works

	<p><b>DANGER</b></p> <p><u>Always</u> disconnect the mains cable from the mains supply before starting any repair, maintenance or cleaning work.</p> <p><u>Always</u> disconnect the connecting plug from the mains supply socket before opening the housing of the welding equipment. Only trained and appropriately qualified personnel are allowed to carry out works at the electric mains supply and welding equipment.</p>
--	--

	<p><b>NOTE</b></p> <p>Only use original SOYER® spare parts.</p>
---	---

### 7.3 Cleaning

Cleaning works should be carried out occasionally depending on how soiled the welding equipment is.

#### 7.3.1 Detergents for cleaning the housing

Almost any detergent without corrosive or acidic substances is suitable for cleaning purposes. However, please observe the manufacturer's specifications on the detergent you intend to use.

## 7.4 Replacement of components

Components may only be replaced by trained SOYER® personnel. The perfect function of your welding equipment can only be guaranteed when original SOYER® spare parts are used.

	<p><b>CAUTION</b></p> <p>Disconnect the mains cable from the mains supply before replacing any components. Electric and electronic components may only be replaced by the SOYER® customer service or by trained and appropriately qualified personnel.</p>
---	--

	<p><b>DANGER</b></p> <p>Disconnect the mains plug from the mains supply when replacing fuses.</p>
---	---

## 8 Troubleshooting

The following list of errors, their causes and remedies is designed to help you eliminate any trouble immediately on the spot. If you cannot eliminate the trouble, please contact the SOYER® customer service responsible for your area or Heinz Soyer Bolzenschweißtechnik GmbH.

	<p><b>DANGER</b></p> <p>Before starting any repair, maintenance or cleaning works, <u>always</u> disconnect the mains cable from the socket.</p>
---	--

	<p><b>CAUTION</b></p> <p>Electric and electronic components may only be replaced by the SOYER® customer service or by trained and appropriately qualified personnel.</p>
---	--



## 8.1 Malfunctions

Error	Cause → Elimination
Welding equipment cannot be switched on.	→ Check mains supply fuses.
Equipment does not weld. No spark formation.	<p>Equipment is not switched on or not connected to mains supply. → Connect system to mains supply and switch on. When switching on the equipment, the LEDs light up shortly.</p> <p>Operating mode is set to pre-current test, gas test or lift drop test. → Set operating mode to operation.</p> <p>Welding cable, control cable or gas hose are not connected properly or are damaged. → Connect cables and/or gas hose properly or check for damage. Replace if necessary.</p> <p>Connecting plug or socket of welding equipment is burnt down. → Have plug or socket replaced by SOYER® customer service.</p> <p>Both earth cables are not properly connected or not connected at all. Earth clamps are not attached to the workpiece. → Connect earth cables; attach earth clamps to the workpiece.</p> <p>Welding points and/or earth connection points at the workpiece are not blank. → Prepare workpiece or studs accordingly.</p> <p>Height of lift and/or depth of immersion are not adjusted correctly. → Refer to the operating instructions of the welding gun to set the height of lift and depth of immersion correctly.</p> <p>Gas flow rate is set too high, i.e. higher than 5 l/min. (arc is extinguished). → Set gas flow rate to a lower value.</p> <p>Stud is too loose in stud chuck. → Press stud chuck together or tighten it.</p> <p>Control of welding equipment or welding gun is defective. → Contact SOYER® customer service.</p>
No shielding gas flow during welding process.	<p>Gas cylinder is not or not properly connected to the welding equipment and/or valve or shut-off valve are not open. → Connect gas cylinder and/or open valve or shut-off valve.</p> <p>Time for gas flow duration is set to "0" → Set gas flow duration to the desired pre-flow time.</p> <p>Gas flow rate is set too low. → Set gas flow rate to 4 - 5 l/min. by means of the regulating valve.</p> <p>Solenoid valve in welding equipment is soiled or defective. → Contact customer service and have it replaced.</p>



Stud does not lift, neither preweld current nor main current arc is generated, even though LED "Stud on workpiece" lights up.	Height of lift is not correctly set. → Set height of lift in accordance with the operating instructions of the stud welding gun.
	Control of welding equipment or welding gun is defective. (Stud does not lift, even though height of lift is correctly set). → Contact SOYER® customer service.
Stud lifts, pre-weld current is initiated, but main current is not ignited.	Operating mode is set to Pre-Current Test. → Set operating mode to OPERATION.
	Pre-weld current arc breaks when switching over to main current. → Clean or abrase workpiece surfaces.
	Lift is too high. → Set lift in accordance with the operating instructions for your welding gun.
	Gas pressure is too high. → Set gas pressure to the specified value.
Varying welding results	Welding energy not correctly adjusted. → Adjust welding energy.
	Cable connections too loose. Transition resistances are generated. → Check all cable connections and earth clamps for tight fit.
	Stud too loose or not fully inserted into stud chuck until stop. → Insert stud into stud chuck until stop. Replace stud chuck, if necessary.
	Magnetic blowing action. Arc is forced into a certain direction. → Alter fixture of earth clamps, place iron parts on the edges and/or rotate welding gun.
	Height of lift and/or depth of immersion are incorrectly set. → Refer to the operating instructions of your welding gun to set the height of lift or depth of immersion correctly.
	You have used low-quality studs with inaccurate dimensions or poor surface finish. → Only use SOYER® welding studs as per DIN EN ISO 13918.
	Welding time and/or gas flow incorrectly set. → Readjust welding time and/or gas flow.
	Parent metal not suitable for welding. → Use suitable material combinations.
Single-fillet bulging at equal points.	Bulging is caused by magnetic blow effect. The arc is forced into a certain direction. → Alter fixture of earth clamps, place iron parts on the edges and/or rotate welding gun.
	SRM current is set to "0" or set too low. → Increase the parameter SRM CURRENT in increments and check to see whether there are any improvements.
Intensive sparking, stud flange almost melted away.	Main current time too long. → Readjust time for main current duration according to the table.
	Welding current too high. → Readjust welding current.

Stud not welded with total flange surface, deficient weld joint strength.	Main current time too short. → Readjust time for main current duration according to the table.
	Poor earth connection → Check earth cables and earth clamps for tight fit, tighten if necessary.
	Workpiece surface too soiled. → Clean workpiece surface.
	Stud face deformed. → Use new welding studs.
	Stud projection over stud chuck incorrectly set. → Set distance between stud chuck and stud face to 2 - 3 mm.
	Welding gun in tilted position. → Ensure that all three gun legs are simultaneously and evenly positioned on the workpiece.
	Lift not correctly set. → Set lift correctly.
Welding equipment switches off.	Stud lift not correctly set. → Set stud lift in accordance with the operating instructions of the welding gun. Switch welding equipment on.
	You have pulled the welding gun off the workpiece while main current has been flowing. → Switch welding equipment on again.
	Arc breaks as gas pressure is too high. → Set gas pressure to the specified value.
	Workpiece surface is poorly electroconductive - arc breaks. → Abrase surface.
	Mains supply is defective. → Check fuses of mains supply.
	Fuse of welding equipment is defective. → Contact customer service.
Stud thread scorched.	Stud chuck worn. → Replace stud chuck.

## 9 Transport and storage

The welding equipment is robustly designed and has a two-piece metal housing with front and rear panel. Owing to electronic components it should be ensured, however, that transport is free from vibrations.

The BMK-12i welding equipment has a carrying handle for easy transport and mobile use over short distances.

	<p><b>NOTE</b> Prevent unauthorized use of the welding equipment by children and unqualified personnel. After long system standstill, we recommend having the stud welding equipment checked by SOYER® customer servicemen prior to start-up.</p>
---	---

	<p><b>NOTE</b> The housing of the BMK-12i welding equipment corresponds to safety class IP 41. Please observe that this system of protection is not suitable for being operated or transported in the rain.</p>
---	---

## 10 Terms of warranty

We warrant for this equipment for a period of 12 months in the case of commercial, professional or equivalent use. When repairs are necessary, we guarantee to undertake them in our factory in Etterschlag. Parts subject to wear and tear are excluded.

Any claim to a warranty will be forfeited if damage is caused by improper operation, if repairs or interferences have been made by unauthorized personnel, or whenever accessories and spare parts have been used which do not match our equipment.

**We cannot guarantee the perfect function of the welding equipment and the quality of welded joints when non-SOYER® welding studs are used.**

---

## 11 List of standards and guidelines

- 2014/35/EU Directive on Low Voltage
- 2014/30/EU Directive on Electromagnetic Compatibility
- EN 60974–1 Arc welding equipment - welding current sources
- EN 60974–10 Arc welding equipment - EMC requirements
- DVS Information Sheet 0901 Arc stud welding of metallic materials
- DVS Information Sheet 0902 Drawn arc stud welding
- DVS Information Sheet 0903 Capacitor discharge stud welding with tip ignition
- DVS Information Sheet 0904 Practical information – Arc stud welding
- EN 14555 Arc welding of metallic materials
- EN 13918 Studs and ceramic ferrules for arc welding
- DGUV Regulation 1 Principles of prevention
- 2006/42/EC Machinery Directive
- EN 12100–1 Safety of machinery – Basic terminology, systems engineering
- EN 12100–2 Safety of machinery – Technical principles and specifications
- EN 60204–1 Electric equipment of machinery, general requirements

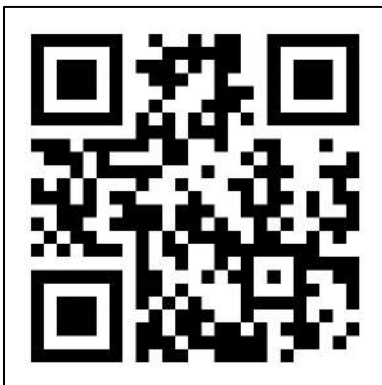

[www.soyer.de](http://www.soyer.de)

**Heinz Soyer Bolzenschweißtechnik GmbH**

Inninger Straße 14 | 82237 Wörthsee | Tel.: +49 8153 8850 | Fax: +49 8153 8030 | E-mail: [info@soyer.de](mailto:info@soyer.de) | [www.soyer.de](http://www.soyer.de)